

Internationale Kommission für die Hydrologie des Rheingebietes

Commission internationale de l'Hydrologie du bassin du Rhin

**Development and testing of a GIS based water balance model
for the Rhine drainage basin**

**Jaap Kwadijk
Willem van Deursen**



Universiteit Utrecht

Bericht Nr. II-15 der KHR
Rapport no. II-15 de la CHR

Internationale Kommission für die Hydrologie des Rheingebietes

Commission internationale de l'Hydrologie du bassin du Rhin

**Development and testing of a GIS based water balance model
for the Rhine drainage basin**

Jaap Kwadijk – Department of Physical Geography Utrecht University

Willem van Deursen – Department of Physical Geography Utrecht University



Universiteit Utrecht

Report no. II-15 de la CHR

©1999, CHR/KHR
ISBN 90-70980-31-2

Vorwort

*Das Wasser ist ein freundliches Element
für den, der damit bekannt ist und es
zu behandeln weiss*

J.W. von Goethe

Damit wir das 'Wasser behandeln können' brauchen wir die Kenntnis über den Wasserhaushalt von Einzugsgebieten. Wir brauchen nicht nur Kenntnis über den heutigen Wasserhaushalt, sondern sollten auch Informationen über die zeitliche Variabilität der Wasserbilanz haben.

Seit Jahren werden im Rahmen der KHR Arbeiten durchgeführt, welche den Einfluss von Klimaänderungen auf den Wasserhaushalt des Rheingebietes untersuchen. Eine Übersicht über diese Arbeiten findet sich in der KHR-Publikation I-16 'Impact of Climate Change on Hydrological Regimes and Water Resources Management in the Rhine Basin'.

Der vorliegende Bericht beschreibt die Entwicklung und das Testen des Wasserhaushaltmodells RHINEFLOW, welches auf der Anwendung eines Geographischen Informationssystems (GIS) beruht und monatliche Abflüsse im Rhein berechnet.

Die Arbeiten wurden von den Herren J. Kwadijk und W. van Deursen im Institut für Physische Geographie der Universität Utrecht durchgeführt. Die KHR dankt den beiden Herren für die wertvolle Untersuchung.

Der Präsident der KHR
Prof. Dr. M. Spreafico

Préface

*L'eau est un élément amical
pour celui à qui elle est familière
et qui sait comment se conduire envers elle*

J.W. von Goethe

Pour «nous conduire envers elle» de façon correcte, nous devons connaître le bilan hydrique des bassins versants. Non seulement les bilans actuels sont nécessaires, mais aussi leur variabilité dans le temps.

La CHR mène depuis des années des recherches sur l'influence des modifications climatiques sur le bilan hydrique. Une vue d'ensemble de ces travaux se trouve dans la publication I-16 de la CHR «Impact of Climate Change on Hydrological Regimes and Water Resources Management in the Rhine Basin».

Le présent Rapport décrit le développement et le contrôle du modèle de bilan RHINEFLOW, reposant sur un système d'information géoréférencée (SIG) et permettant le calcul des débits mensuels du Rhin.

L'étude a été réalisée par MM. J. Kwadijk et W. van Deursen de l'Institut de géographie physique de l'Université d'Utrecht. La CHR les remercie pour leurs recherches.

Le président de la CHR
Pr Dr M. Spreafico

TABLE OF CONTENTS

	<i>Page</i>
Vorwort	3
<i>Foreword (in German and French)</i>	3
Abstract	7
1 Introduction	9
1.1 Hydrological setting of the Rhine basin	10
1.2 Current knowledge of impact of climate change on water resources	10
1.3 Current knowledge about the impact of climate change on the River Rhine	12
1.4 Objective	12
2 Model concept	13
2.1 General	13
2.2 Model concept of the RHINEFLOW model	13
3 Modelling flow types between the water balance compartments	17
3.1 Snow cover storage and snow-melt	17
3.2 Evapotranspiration and water storage in upper soil layers	17
3.3 Water storage in deep groundwater and delayed runoff	18
4 Input data	21
4.1 Input variables and parameters for the model	21
4.2 Calibration and validation time series	29
4.3 Considerations for the use of the 3*3 kilometres grid size	29
5 Implementation of the GIS data base into the water balance model using the watershed tools	31
6 Calibration and validation of the model	39
6.1 Discharge representation	39
6.2 Validation of the evapotranspiration calculations	42
6.3 Validation of the snow cover and snow storage calculations	42
6.4 Sensitivity of the separation and recession coefficients	43
7 Sensitivity analysis of the discharge at the downstream (Dutch) part of the River Rhine	47
7.1 Calculation of discharge scenarios	47
7.2 Results	48
8 Conclusions and discussion	51
8.1 Model performance and application	51
8.2 Model restrictions	51
8.3 Recommendations	52
References	53
Appendix: The calculation of the total water balance	57
Publications of the CHR	61
Some information on the CHR (German, French, Dutch and English)	63

ABSTRACT

A water balance model, called RHINEFLOW, has been developed, to investigate month to month changes in the water balance compartments in the Rhine basin. The model is based on a Geographical Information System (GIS). RHINEFLOW is designed to study the sensitivity of the discharge of the River Rhine to a climatic change. The model development is part of a project initiated by the Commission for the Hydrology of the Rhine Basin (CHR/KHR). The major objective of this project is to study the impact of climate and land use changes on the River Rhine.

RHINEFLOW uses the standard meteorological input variables of temperature and precipitation, and the geographical data on topography, land use, soil type and groundwater flow characteristics. These parameters are stored in a raster GIS with a spatial resolution of 3*3 km. Calculations of evapotranspiration, runoff and snow-melt, are based on the Thornthwaite-Mather method for actual and potential evapotranspiration and a temperature-index method for snowfall and snow-melt. The model separates monthly water surplus into direct runoff, which comes to discharge in the same month, and delayed runoff. Stream flow calculations are corrected by using data on lake water storage changes and changes of water storage as glacier ice. The model produces time series for the river discharge. It also produces maps showing the temporal and spatial distribution of a number of hydrological variables such as potential and actual evapotranspiration, snowfall percentage, snow cover duration etc.

RHINEFLOW has been developed in conjunction with the raster GIS using the WATERSHED toolkit. WATERSHED is a set of utilities developed for hydrological and geomorphological modelling that can be linked to a raster GIS. These utilities allow water balances to be modelled for each of the cells of the raster system. The utilities include a geomorphological routing routine which allows water computed from the water balance to flow along the drainage network to the outlet of a catchment.

The model is calibrated and tested by comparing calculated and observed discharge, snow water storage and evapotranspiration. RHINEFLOW has been calibrated using the relative wet 1965-1969 period and has been validated on the 1956-1980 period. Despite its simplicity, the model performs quite accurately. Except for one station, annual discharge is estimated by the model within 5 percent of the observed value for sub-catchments (3,000 km² and larger) under different environmental conditions, as well as for the whole catchment (160,000 km²). Model performance on month to month variation in stream flow is tested with the coefficient of efficiency, an indication of goodness of fit. Depending on the sub-basin, the model efficiency ranges between 0.72 and 0.81. Comparing model average areal monthly actual evapotranspiration with published data showed that the model is capable to represent the actual evapotranspiration accurately both in the Alpine basins and in the lowland basins. Also snow water storage is quite well represented at different latitude zones in the Alps.

Sensitivity studies have been carried out for average annual precipitation changes between -20% and +20%, combined with average annual temperature changes between 0°C and +4°C. The results show that, within this range, the discharge in the downstream (Dutch) part of the River Rhine is more sensitive to a change in precipitation than to a temperature change. With respect to climate change this implies that future precipitation scenarios must be quite accurately indeed, to be used for hydrological impact studies. For the development of a detailed model for the River Rhine, in the first place research effort must be put into the accurate estimation of areal precipitation. Secondly, the evapotranspiration and snow-melt processes should be modelled on a physical basis since these are the most sensitive for climate change. The water movement in the soil and in the lower aquifers can be modelled empirically because there is no possibility to obtain the data necessary for modelling this water flow physically; and it is unlikely that the properties of these compartments will alter under a climate change.

1 INTRODUCTION

The climate is expected to change due to the enhanced greenhouse effect. This will change precipitation and temperature distribution in time and space. Consequently stream flow is expected to change in volume and distribution over the year. Long-term strategies for future river management require quantitative information on these changes. In order to obtain this information hydrological models can offer an important tool.

In Western Europe the River Rhine is the most important river. Its basin of approximately 185,000 km² stretches from the Alps to the North Sea (fig.1). Two thirds of its basin are situated in the Federal Republic of Germany. The Alpine countries, of which Switzerland is the most important, form 20% of the area.

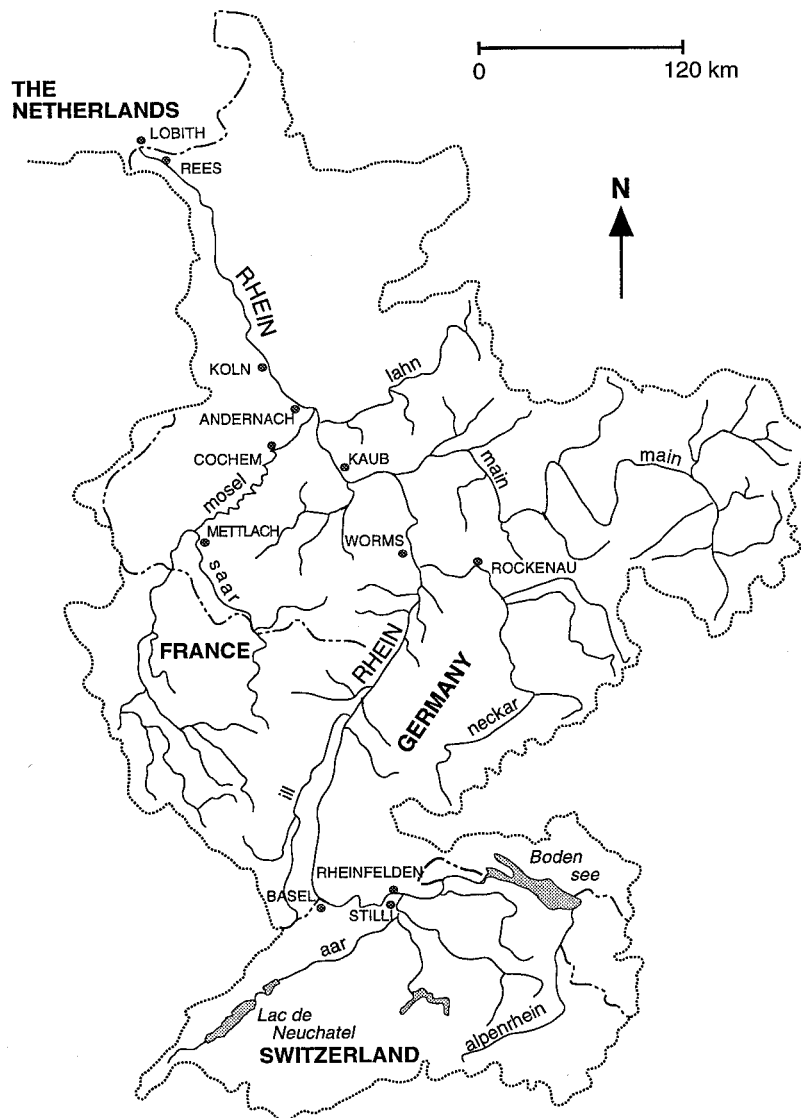

Figure 1 Location map

The river has the world's highest traffic density for inland waterways. Besides this navigation its economic importance is great because it forms the water supply for industrial, domestic and agricultural purposes. In the downstream region (The Netherlands) large amounts of Rhine water are used to prevent salt intrusion in the Rotterdam Waterway and flush out saline upward seepage from the deep groundwater in the low-lying polder area (CHR/KHR, 1976).

Possible future changes in discharge and river behaviour, as a result of a climatic change, as triggered by a greenhouse effect, may have large impact on the above mentioned water supply.

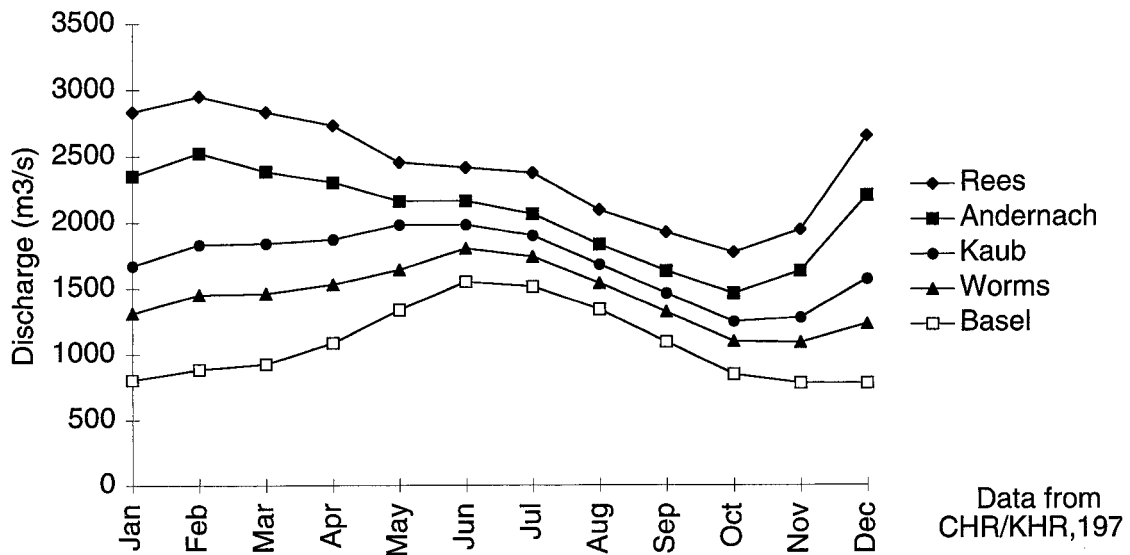

Figure 2 Hydrographs for major gauging stations along the River Rhine

1.1 Hydrological setting of the Rhine basin

The water balance of the River Rhine has been studied with respect to changes in different water balance compartments on a monthly time basis for the periods 1958-1959, 1969-1970 and 1976 (CHR/KHR, 1976; CHR/KHR, 1983). According to these studies the discharge of the River Rhine is mainly determined by the amount and timing of precipitation, the general evapotranspiration surplus during the summer period and changes in the amount of groundwater and soil water storage. For the area upstream of Basel (Switzerland) the hydrograph is determined by changes in the amount of snow storage, which are determined by both temperature and precipitation and in the amount of water stored in the lakes, which are mostly artificially regulated. For the basin downstream of Basel these processes are of minor importance. In this part monthly runoff is mainly determined by groundwater recharge. Groundwater recharge is less important in the Alpine area because the volume of unconsolidated sediments, potential aquifers, is small. On the basis of these hydrological properties and landform the basin can be divided into a mountain area (Alps) upstream of Basel and a middle and lowland part downstream of Basel. The flow regime of the Rhine is characterised by the hydrographs of a number of gauging stations along the river (Fig.2). Although the area upstream of Basel represents only 20% of the total area of the Rhine catchment, it produces almost 50% of the discharge of the river. In dry periods, like the summer of 1976, the proportion of the discharge coming from the Alps can increase to 95% (CHR/KHR, 1983).

1.2 Current knowledge of impact of climate change on water resources

With respect to changes in runoff and water resources due to climate change, changes in evapotranspiration and precipitation patterns are highly relevant. Ideally, the climate simulations from General Circulation Models (GCMs.) could be used directly to drive hydrologic models. However, the accuracy of their present predictions of climatic change are insufficient for use in hydrological simulation studies on a regional scale (W.M.O., 1987) or e.g. on the scale of the drainage area of the River Rhine. This is caused by the low spatial resolution of the climate models, the low significance of the results of their present-day precipitation calculations and the restriction of their output to average values. Because of these uncertainties usually hypothetical scenarios of precipitation are used, ranging from -25% to +25% (e.g. Mimikou et al., 1991). Estimations of changes in annual runoff due to climatic change range from a decrease of 40-75% (Revelle and Waggoner, 1983) to an increase of 0-100% (Idso and Brazel, 1984), depending on the assumptions used. In a theoretical approach Wigley and Jones (1984) showed that annual runoff depends more on precipitation changes than on changes in evapotranspiration. More recently Bultot et al. (1988), using a conceptual daily step model, showed that climatic warming will result in increased winter runoff and decreased summer runoff for medium-sized catchments in Belgium. The exact nature of these changes depends on the geohydrological properties of the basins. Mimikou et al. (1991) showed for medium-sized basins in Greece that, in basins where regional characteristics limit water retention, a minimal sensi-

Author	Year of publication	Area, basin	Time-basis	T-change	P-change	Other scenarios	Runoff change (%)
Stocton & Boggess	1979	W. USA mean of 7 basins	Annual	+2 °C	-10%		from -40 to -76
Nemec & Schaake	1982	Arid basin	Annual	+1 °C	10%		50
Nemec & Schaake	1982	Arid basin	Annual	+1 °C	-10%		-50
Nemec & Schaake	1982	Humid basin	Annual	+1 °C	-10%		25
Nemec & Schaake	1982	Humid basin	Annual	+1 °C	-10%		-25
Revelle & Waggoner	1983	Colorado basin	Annual	+2 °C	-10%		-40
Revelle & Waggoner	1983	Colorado basin	Annual	+2 °C	-10%		-18
Flaschka	1984	Great Lakes basin	Annual	+2 °C	-10%		from -17 to -38
Idso & Brazel	1984	Humid basins	Annual	+2 °C	-10%	Anti-transpirant effects of CO ₂	-41
Idso & Brazel	1984	Humid basins	Annual	+2 °C	-10%	No anti-transpirant effects of CO ₂	42
US Environmental Protection Agency	1984	USA central states, USA North West	Annual	+2 °C	-10%	Double CO ₂ concentration in the atmosphere	from +20 to +60
Klemes & Nemec	1985	Peace river (arid, Canada)	Annual	-1 °C	-25%		-67
Klemes & Nemec	1985	Leaf river (humid, USA)	Annual	-1 °C	-25%		-53
Klemes & Nemec	1985	Leaf river (humid, USA)	Annual	+3 °C	-25%		49
Klemes & Nemec	1985	Peace river (arid, Canada)	Annual	+3 °C	-25%		154
Gleick	1987	Sacramento basin, California	Summer	+2 °C	-10%		-32
Gleick	1987	Sacramento basin, California	Summer	+2 °C	10%		-12
Gleick	1987	Sacramento basin, California	Summer	+4 °C	-10%		-68
Gleick	1987	Sacramento basin, California	Summer	+4 °C	10%		-56
Gleick	1987	Sacramento basin, California	Winter	+2 °C	-10%		-9
Gleick	1987	Sacramento basin, California	Winter	+4 °C	10%		54
Gleick	1987	Sacramento basin, California	Winter	+4 °C	-10%		14
Gleick	1987	Sacramento basin, California	Winter	+2 °C	10%		25
Flaschka & Stockton	1987	4 basins Utah, Nevada (USA, arid?)	Annual	+2 °C	-10%		from -17 to -28
Flaschka & Stockton	1987	4 basins Utah, Nevada (USA, arid?)	Annual	+2 °C	-25%		from -33 to -51
Flaschka & Stockton	1987	4 basins Utah, Nevada (USA, arid?)	Annual	+2 °C	10%		from +17 to +28
Flaschka & Stockton	1987	4 basins Utah, Nevada (USA, arid?)	Annual	-2 °C	10%		from +33 to +51
Sanderson & Wong	1987	Great Lakes basin	Annual	-2 °C	25%	General Circulation Model, double CO ₂ concentration in the atmosphere	from -12 to -13
Singh	1987	Great basins Quebec, Canada	Annual			Double CO ₂ concentration model 1	from +7 to +18
Singh	1987	Great basins Quebec, Canada	Annual			Double CO ₂ concentration model 2	from +14 to +20
Palutikof	1987	Basins in Great Britain (England & Wales)	Annual		-2% to -9%	Evaporation change 0%	from -5 to -25
Palutikof	1987	Basins in Great Britain (England & Wales)	Annual		-2% to -9%	Evaporation change -15%	from 0 to +20
Palutikof	1987	Basins in Great Britain (England & Wales)	Annual		-2% to -9%	Evaporation change -30%	from +20 to +40
Bultot	1988	Basins in Belgium	Annual	+2.9 °C	5%	Double CO ₂ concentration	from +3 to +10

Table 1 Discharge changes due to climate change for different catchments in the world (based on Shiklomanov, 1989)

tivity of runoff to temperature changes is exhibited. The study also showed that effects of precipitation change upon the quantities of runoff are characterised by a magnification factor. Table 1 shows an overview of the results on the assessment of the effect of climate changes on river runoff in North America and Western Europe (Shiklomanov, 1989). For larger drainage basins only scenario analysis for discharge changes on a seasonal to annual time basis have been carried out. An example is the study into the stream flow changes of the Sacramento river (Gleick, 1987b).

From these studies the conclusion can be drawn that none of the existing approaches is useful for a spatially distributed modelling of the effects of climate change in large basins on a monthly time basis, since they all act on a longer temporal resolution or on a lower spatial resolution.

1.3 Current knowledge about the impact of climate change on the River Rhine

The scenario for a changed discharge of the River Rhine used by the Dutch Institute for Inland Water Management and Waste Water Treatment (Rijkswaterstaat/RIZA), assumes a decrease of at most 10% in summer discharge and an increase of at most 10% in winter discharge as a 'Worst Case' scenario (Rijkswaterstaat, 1988). This scenario uses global GCM results that estimate a 10% increase both of precipitation and of evapotranspiration. The scenario also expects increasing snow-melt in the winter period in the Alpine part of the basin due to the temperature rise. Recently a study was carried out to estimate the sensitivity of discharge of the River Rhine to two environmental changes. Firstly to a change in snow covered area due to a rise of 4°C in winter temperature in the upland part (Alps) of the drainage area and, secondly, to a large land use change in the lowland area between Basel and Lobith (The Netherlands). The main result was that both environmental changes altered the discharge at the downstream (Dutch) part of the River Rhine about 10%. The land use change resulted into a 9-10 % decrease of the annual runoff while the temperature change resulted into a decrease of 13-15 % in summer discharge. The results of the estimations also indicate that the reduction of the summer discharge due to climate change could be larger than the 'Worst Case scenarios' mentioned (Kwadijk, 1991).

Hitherto no precipitation-runoff models have been developed with an ability to simulate the discharge of the River Rhine at a catchment size of the major tributaries. Therefore a KHR/CHR project to assess the impact of climate and land use changes on the discharge pattern of the River Rhine started recently. The main objective of this project is to develop a water management model that can be used to simulate changes of the daily discharge of the River Rhine and its tributaries as a result of climate and land use changes. For this project departments for river management of the Rhine countries cooperate, together with several universities. The project uses a bottom-up approach to develop this model. The drainage basin is divided into four distinct sub-areas, the Alpine region, the Middle mountains, the undulating so-called Schichtstufen area and the lowland area. During the first phase of the project, models for representative drainage basins within each of the sub-areas will be developed. They should as far as possible describe the hydrological processes on a physical basis. In the second phase of the project these models will be coupled (CHR/KHR, 1991).

However, such models are both complex and demanding in terms of data input and computer capacity. Since data for meteorological and hydrological variables are relatively easy to obtain, as a first step a simple water balance model has been developed to provide information within a short time on a lower temporal (month) and spatial resolution (major tributaries). This report deals with the development of this water balance model.

1.4 Objective

The objective of this study is to develop and test a model, named RHINEFLOW, for the River Rhine that is able to describe the changes in the water balance compartments on a monthly basis on the scale of the entire basin and its tributaries. The model is based on a GIS (Geographical Information System). The purpose of the model is to estimate the sensitivity of the runoff regime of the River Rhine to possible changes in precipitation and temperature. The approach assumes that the hydrological processes responsible for runoff production will not change as a result of climate change. It is the purpose to evaluate this type of model for its use for climate effect studies.

2 MODEL CONCEPT

2.1 General

The hydrological cycle of a drainage basin can be viewed as a series of storages and flows. A water balance is often used as a framework to describe the transformation of input (precipitation) through this cycle. In such a model the water budget can be reduced to a simple mass balance equation:

$$\text{Inflow} - \text{Outflow} = \text{Storage Change}$$

The simplest water balance models have a single store or two stores. For the single store, its contents are determined by the single (or multiple) inflows and outflows. For two stores, the outflow of the first store forms the inflow of the next. The stores can represent successive sections down a river channel or different layers within the ground. An extension is to a chain of stores representing an area, with the possibility of flows from cell to cell. (e.g. Kirkby et al., 1987).

In a water balance model for catchment hydrology, inflow is determined by precipitation and outflow by river flow and evapotranspiration. Storages are vegetation storage, surface detention, snow and glacial storage, soil storage, groundwater storage, lake and channel storage. Several flow types can be characterised between the storages, e.g. through fall from the vegetation on the ground, surface flow if the through fall exceeds the infiltration capacity of the soil, gravity flow from the soil to the groundwater, through flow from the soil to the channel and base flow from the groundwater to the channel. Inflow and outflow in the various storages are controlled by external factors, such as soil type for the infiltration capacity, landform for surface runoff and vegetation for interception and vegetation storage. To which extend the different storage compartments and flows are incorporated into a model concept, depends on the application of the model and the temporal and spatial scale at which it might reasonably be expected to work.

The algorithms used to describe the different flows through the compartments may differ from completely empirical to more conceptual, depending on how much consideration is given to the physical processes acting on the input variables to produce the outflow.

During the last decades many models have been developed that describe the transformation of precipitation into runoff (e.g. Franchini and Pacciani, 1991). However, existing models that can be applied to different basins such as the SACRAMENTO model, TOPMODEL (Beven et al. 1984), and the SHE model (Abbot et al., 1986), require large detailed data sets both in space and in time. Even in a densely measured area such as the River Rhine catchment, data for many of the parameters such as geo-hydrological properties, land management and vegetation types, and hydraulic channel properties are only available at a very low spatial resolution. One can use statistical methods to estimate these values from small scale plots or laboratory studies, but the problems of up-scaling these parameters and variables to large scale phenomena are still unsolved (e.g.. Beven, 1989). This implies that there are no accurate data to feed these models. Finally, due to their large spatial and temporal resolution the models are very time consuming in computing when used for a large catchment as the River Rhine. Consequently, these models are too complex for an approach to model the Rhine catchment on a monthly time basis using a limited data set and limited computing resources. As a result, the discussions between the members of the CHR-KHR lead to the conclusion that there were no existing models that could be integrally used for modelling the River Rhine (CHR/KHR, 1991).

2.2 Model concept of the RHINEFLOW model

Since no existing models were appropriate, we developed a new model, named RHINEFLOW. RHINEFLOW uses a frame work of the major storage compartments as published by the CHR-KHR (CHR/KHR, 1976). The discharge regime of the Rhine is governed by five major natural storages and controls:

- The amount of precipitation and its spatial distribution.
- The temperature distribution in the catchment, which mainly depends on the topography. This distribution forms the main control for the amount of snow storage, snow-melt and potential evapotranspiration in the catchment.

- Soil moisture storage/shallow ground water which gains water from the surplus of precipitation and loses water to evapotranspiration, to seepage to the deeper groundwater and to the direct runoff.
- Deeper Groundwater storage which gains water from the soil water seepage and loses water to the river base flow.
- The distribution of the land use and soil water storage capacity in the catchment, which control the actual evapotranspiration.

One additional storage can be recognised, which is mainly determined by human management:

- Storage in lakes.

Since these storages and controls vary spatially, the model variables and parameters are stored in a raster Geographical Information System (GIS).

RHINEFLOW describes the water balance at location (x) in month 'i' by:

$$R_i = P_i - AE_i + dS_i \text{ (mm)}$$

$$S_i = SS_i + GWS_i + SNS_i \text{ (mm)}$$

in which

- R = the runoff (mm),
- P = is precipitation (mm),
- S = the water volume stored in the soil, snow and groundwater (mm),
- AE = water loss due to actual evapotranspiration (mm),
- dS = change in water volume stored (mm),
- SS = water stored in the soil and as shallow groundwater),
- GWS = the water stored in aquifers and as deeper groundwater),
- SNS = the amount of water stored in the snow cover.

This approach assumes that water balance at a time (t) in a location (x) depends only on the local previous conditions at (t-1) of the storages and the water produced by precipitation and snow-melt at (t). Water produced by overland flow in one location is not expected to supply to infiltration in another (lower) area. It assumes that all water for runoff produced at (x,t) is assigned to the stream flow. Whether or not this assumption is accurate, depends on the scale the model has been developed for. This is discussed in section 3 and 4.

To obtain stream flow in a catchment from local water production the water production in the upstream area must be known. Hence, the spatial connection of the geographical sub-elements in the catchment must be known. In this study these elements are represented by the grid-cells of the raster GIS. The approach to connect the elements is based on geomorphologic routing. Each grid-cell drains towards the lowest neighbouring grid-cell, and by subsequently following the direction towards the lowest neighbour, the flow path of runoff is established. This assumes that groundwater will flow in the same direction as the surface water. Although within a catchment local groundwater flow direction may be different from that of the surface water, over large areas they will approximately be the same. Therefore, this is a reasonable assumption for large areas. Figure 3 shows a flow diagram for the RHINEFLOW model concept.

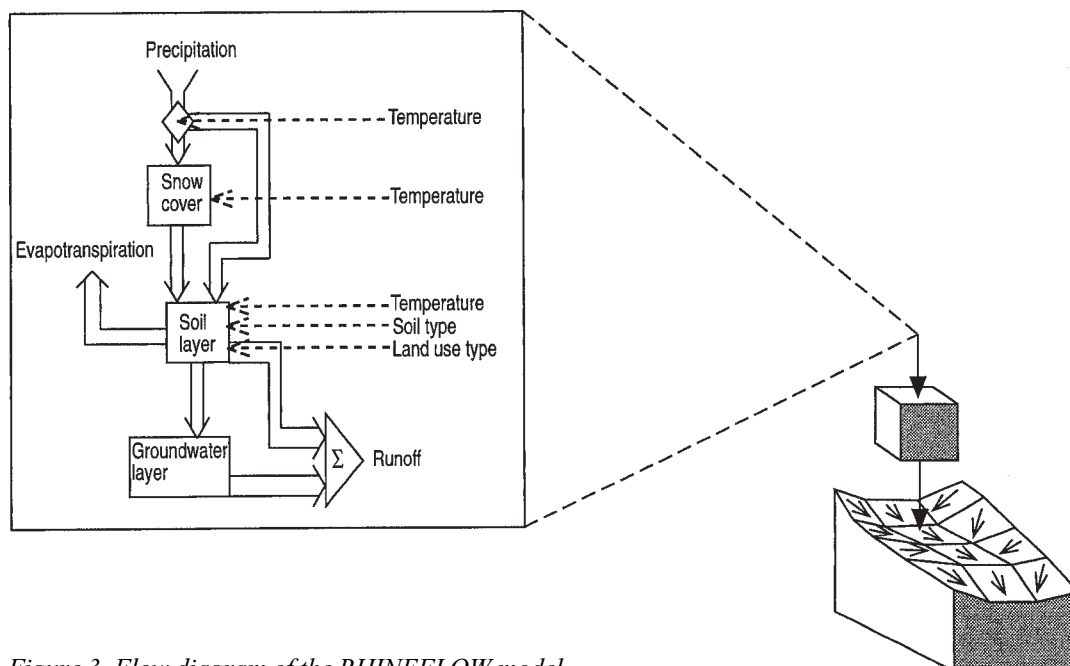

Figure 3 Flow diagram of the RHINEFLOW model

To model the changes in the compartments the following steps are necessary:

- 1 Read input data for a certain location (x,y) and time step (t).
- 2 Carry out the necessary calculations to determine the water balance at (x,y,t) from the initial conditions at (x,y,t-1) and the new input data.
- 3 Determine the spatial connection between the cell (x,y) and the outlet of the catchment.
- 4 Carry out the calculations to determine the discharge at the outlet of the catchment(s), based on the spatial connectivity.
- 5 Produce output data series or maps, to enable others (users or models) to use the results of the model.
- 6 Carry out the water balance calculations repeatedly in order to model dynamically and to produce time series as a result.

To carry out these procedures the RHINEFLOW model has been developed using the GIS toolbox WATERSHED. This toolbox is not an implementation of one specific model, but a set of modules for building spatially distributed (hydrological) models. (Van Deursen and Kwadijk, 1990 and 1993). The approach is basically an extension of the one used by Tomlin (1983) when he designed the Map Analysis Package. The tools include modules to perform grid-cell calculations, input and output from time series and the possibility to derive spatial connections (drainage networks) from Digital Elevation Models.

In the following sections the equations used by RHINEFLOW to describe the flows between the different stores are discussed (section 3). The GIS data base used is presented (section 4) and the implementation of the RHINEFLOW model into the WATERSHED tools is shown (section 5).

3 MODELLING FLOW TYPES BETWEEN THE WATER BALANCE COMPARTMENTS

3.1 Snow cover storage and snow-melt

Snow-melt is generally calculated on a time basis of one day or shorter. The models that describe the storage and melt processes vary from energy balance models simulating the flow of mass and energy in the snow cover to simple black box models that simulate daily discharges using average daily precipitation and temperature (Braun, 1985). The latter type of models are referred to as temperature-index snow-melt models. Despite their low physical basis, they are widely used in forecasting discharge in snow covered basins. The general form of these models is:

$$Q_s = (T_m - T_0) * c_0 \left(\frac{L}{t^I} \right)$$

in which

- Q_s = the snow-melt ($L * t^{-1}$)
- T_m = the average daily temperature (K)
- T_0 = a critical temperature above which snow-melt starts (K)
- c_0 = the melt rate per degree Celsius ($L * K^{-1} * t^{-1}$).

The procedure to calibrate these models is to find a set of T_0 and c_0 which gives in combination with a discharge model the best fitting hydrograph compared with the observed one (e.g. Braun, 1985; Moussavi et al., 1989; Gleick, 1987a). The optimal set of T_0 and c_0 can vary considerably from basin to basin and from year to year (Braun, 1985). Only recently, reliable data on long-term average Snow Water Equivalents (SWE) for different locations in the Alps became available, which permits an independent control of the snow module (Martinec et al., 1992). However, since snow storage is strongly dependent on local conditions, point data can only give a rough estimate for snow storage over large areas. The amount of water stored as snow during the winter period over large areas is not yet known. A research project into the up-scaling of the point data on SWE to areal values is still in progress (Braun, pers. comm.). Snow storage and snow-melt calculations on a monthly time basis can give only a very rough indication of the snow cover changes because in large parts of the Alpine area snow cover build-up and decay takes place several times a month (Braun, 1985). Gleick (1987a) states that temperature-index models using monthly data give a poor representation of the discharge during periods of snow-melt. For the Sacramento model he uses the equations of Thornthwaite-Hylckama based on average monthly temperature as a trigger determining when snow-melt starts and altitude which determines the rate of snow-melt when started.

We chose a simple temperature-index model based on average monthly temperature because test runs gave reasonable results in calculating spring discharges and timing of the snow-melt in different basins in the Alpine region. T_0 and c_0 were determined by calibration of the calculated winter and spring hydrographs to the observed ones for the catchments in the Alpine region. A critical temperature (T_0) at which snow-melt starts of zero degrees Celsius and a melt rate of 18 ($mm * C^{-1} * month^{-1}$) offered the best results.

3.2 Evapotranspiration and water storage in upper soil layers

In the Rhine drainage basin methods for calculating evapotranspiration differ from country to country. In Germany the equations of Haude, while in the Netherlands those of Makkink are used. There is no standard method to convert the results obtained from the different methods to each other. Since monthly temperature data are easily available and GCM output of temperature is relatively well validated (e.g. Washington and Meehl, 1984; Wilson and Mitchell, 1987), we determine evapotranspiration using the temperature dependent Thornthwaite equation. For actual evapotranspiration the results were modified with a factor for different rates of evapotranspiration as a function of land use type. This factor was determined in the first place by calibration of the calculated average annual runoff for the entire basin to the observed annual runoff. Differences between land use types are based on published data. (Brechtel and Scheele 1982). Using the equations of Thornthwaite and Mather (1957) the calculations for actual evapotranspiration also take possible soil water deficiencies into account. This approach is also followed by Gleick (1987a) in the Sacramento basin and by Thompson (1992). This method has been criticised as overly simplistic but 'despite its inherent sim-

plicity and limitations Thornthwaite's method does surprisingly well' (Penmann, 1956). Thornthwaite's method has been evaluated recently by Pereira and de Camargo (1989). They also found it reliable and in their opinion many of the past criticisms are unwarranted or ill-founded.

The water surplus in one month (precipitation plus snow-melt minus evapotranspiration minus snow storage) is first added to a possible soil water deficiency. The remaining part of the surplus is proportionally separated into rapid runoff, which is available for the discharge in the month of concern, and a volume of water which is added to the groundwater storage. This separation coefficient has been obtained by fitting the calculated rising limb of the basin hydrograph at the Lobith gauging station, to the observed hydrograph using months with large discharges. The separation coefficient has been defined as:

$$x = \frac{SPW}{RS} \quad (-)$$

where

SPW = water added to the deeper groundwater (mm/month)
 RS = the rapid runoff (mm/month)
 x = the separation coefficient (0.2) (-)

This coefficient depends on various basin characteristics such as steepness, soil physical properties, and land use. However, no information is available to quantify the effects of these basin properties for this separation coefficient. Also no data is available about monthly variations in soil water storage within the time schedule of the project. Therefore, the calculation results for these variations cannot be independently controlled. For these reasons and to keep the model as simple as possible, the model uses the same separation coefficient, 20% vs 80%, for the entire basin.

Since the value of the parameter may change when climate would change, sensitivity of the model has been tested for variations in this coefficient. The results are presented in section 6.4). Alternatives for separation of different flow types, using a more physically-based approach, will be discussed in context to the scale used in section 4.3.

3.3 Water storage in deep groundwater and delayed runoff

The delayed runoff (R_s) representing the base flow, is calculated from the groundwater storage using the recession equation

$$R_s = \frac{GWS}{C} \quad (mm/month)$$

where

GWS = the water volume stored as groundwater (mm)
 C = a recession parameter (months).

The constant C (month) in the recession equation has been obtained by calibration for the main tributaries. The calculated hydrograph of these tributaries has been fitted, using C, to the observed hydrograph for months with small discharges. For these months it is assumed that all river runoff originates from the base flow. It is assumed that this parameter C is mainly dependent on the geohydrological properties of a catchment and these properties will probably not alter under changing climatic conditions. Table 2 shows the calibration results for C for the main catchments. Generally mountain basins, with small groundwater storage are characterised by low values for C, whereas flat areas, with a larger storage capacity have higher C values. As fluctuations in the deeper storage compartments cannot be independently controlled, model sensitivity has also been studied for variations in this parameter C (section 6)

The runoff in a cell was calculated by:

$$R_n = R_s + R_q \quad (mm)$$

The discharge in a basin was calculated by:

$$Q = \left(\frac{\sum R_n}{N} \right) (mm)$$

where

Q = the discharge in the basin (without lake storage and glacier water storage changes) (mm),
 N = the number of cells in the basin (-).

River section	Recession parameter C (month)
Aar	4
Alpenrhein	3.5
Rock outcrops, glacial area	1.1
Reuss	2
Limmat	2.5
Neckar	4.5
Main	6
Mosel	3
Saar	2
Rhine valley	5

Table 2 Calibrated recession parameters for the major basin sections

This model concept for discharge calculation in a basin assumes that all water available for runoff ($R_s + R_q$) in a month, will reach the outlet of the catchment within the same month. Therefore, both the separation coefficient (x) (eq.4) and the recession coefficient (C) (eq. 5) represent the response characteristics of a catchment to rainfall or snow-melt. Low values of C and high values of x represent a short response time (relatively steep hydrographs), whereas high values of C and low values of x represent a long response time (relatively flat hydrographs). This response time does not only include the period of time that the water (precipitation) uses, once it has fallen on the ground, to reach a river, but also the time which the water needs to flow through the channel to the outlet of the catchment. Using a monthly time step, this last term can be ignored in small catchments. However, for the River Rhine this may lead to errors because it takes water approximately nine days to flow from Rheinfelden (Switzerland) to the catchment outlet at Lobith. Therefore, if a large amount of precipitation would fall during the last 5 days at the end of a month in the southern part of the basin, the model will over-estimate the discharge at the outlet of the basin at Lobith for that month. For the next month the model will under-estimate the discharge at Lobith. Assuming that the water balance has accurately been calculated, calculated discharge averaged over the two months will be similar to the averaged observed discharge.

Whether or not this model error is important can be determined from analysis of the month to month discharge variations at the Lobith gauging station. If the time step used leads to structural model errors, this will inevitably result into low values for the coefficient for model efficiency (Nash and Sutcliffe, 1970) for this station. The results of investigations to the model efficiency will be presented in section 6.

4 INPUT DATA

For the RHINEFLOW model a raster GIS data base has been created. The different maps in this data set were digitised and rasterised to a grid size of about 3*3 kilometres. Each of these raster cells in the data base represents one calculation element in the RHINEFLOW model and is the smallest element in the spatial connectivity analysis.

4.1 Input variables and parameters for the model:

- *Monthly areal precipitation*

The set includes monthly areal precipitation from 1900 to 1980 of the catchments of several (16) segments of the River Rhine and of the main tributary catchments. These data were obtained from the German and Swiss Meteorological Offices (DWD and SMA). The location of the areas is shown in figure 4. The spatial distribution of the precipitation within these sub-areas is not taken into account. Schädler (1985) following Sevrük (1985) estimated that systematic errors for these data for catchments in Switzerland are from 3% to over 25% even for periods covering several years. This is by far the largest error for all time series used. Using this data will obviously lead to errors in the water balance calculations. However, these are the best records available. For the basin sections downstream of Basel this error is probably smaller since spatial variability of precipitation in mountain areas is much larger than in lowland areas.

- *Monthly temperature*

Monthly temperature data was used for 27 stations. The maximum length of the temperature records covered a time period from 1900 to 1989. The shortest record extended from 1957 to 1980. This data was also obtained from the DWD and SMA. Monthly average temperatures are calculated daily temperature values.

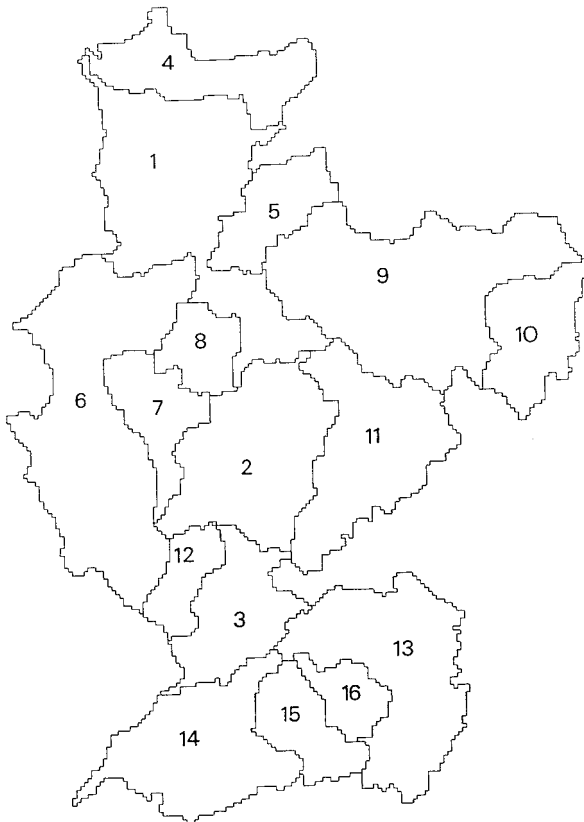

Figure 4 Areas used for precipitation input. Numbers correspond with the numbers in table 3

Calculation methods for these daily values differ from country to country. In Switzerland temperature is measured three times a day, at 7.30; 13.30 and 21.30. Daily temperature is derived by averaging these values, whereas the measurement at 21.30 is counted twice. Germany uses the same method, however the time of measurements differ from that of the Swiss. In France daily minimum

and maximum temperatures are averaged. In this study no correction have been made for possible variations in temperature due to different calculation methods. Thiessen polygons were constructed around the locations (cell) of the stations. Figure 5a shows the location of the stations used and figure 5b the polygons around the stations. It is assumed that the station within the polygon is representative for the cells in that polygon.

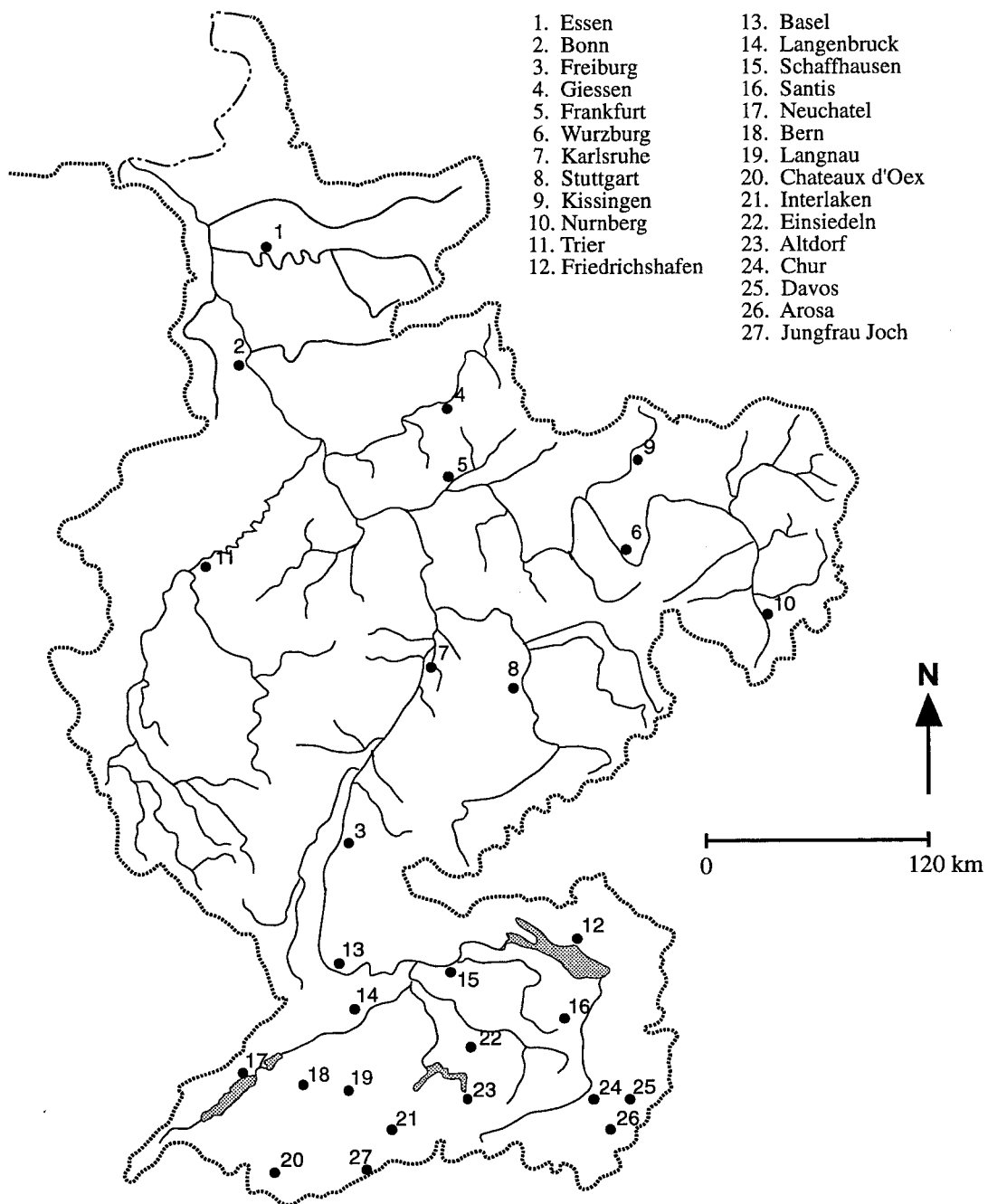

Figure 5a Location map of the temperature stations

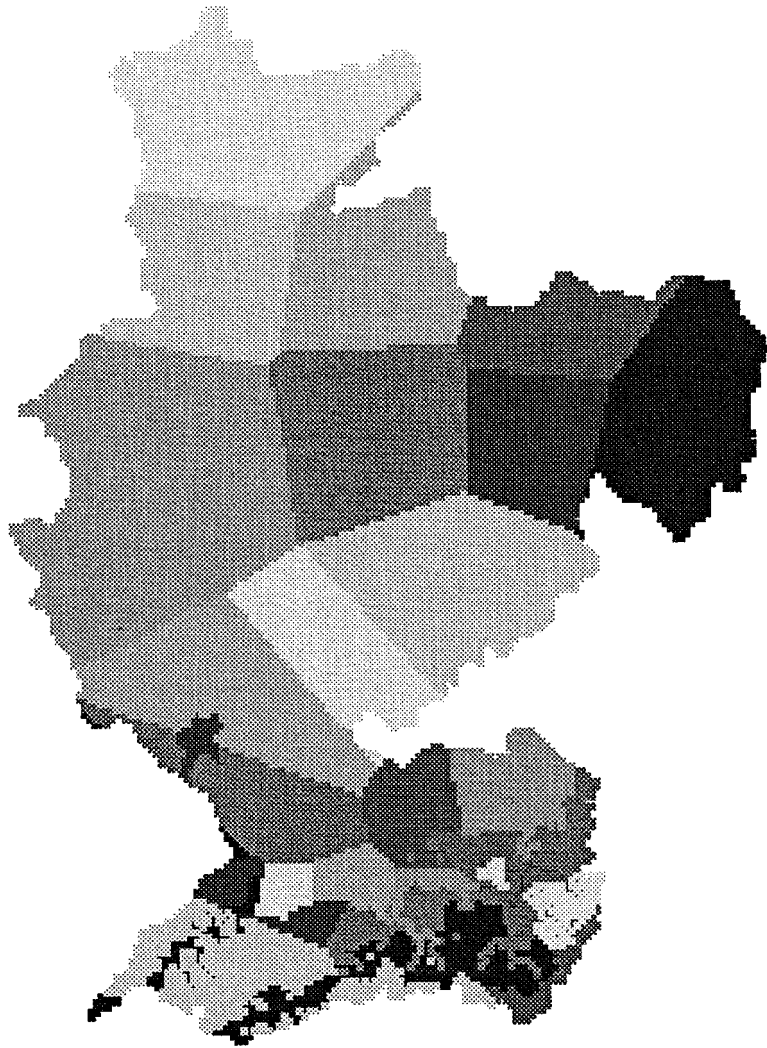

Figure 5b Thiessen polygons for temperature stations

The temperature in a given raster cell is obtained from the temperature of the representative weather station and is corrected for the altitude of that cell with the use of elevation data from the Digital Elevation Model (DEM), assuming a 0.57°C temperature decrease for a 100m rise in altitude. This was an average value determined by comparison average monthly temperatures of stations at different altitudes. For the Alpine area the procedure was somewhat different. The elevation has been divided into the zones $<700\text{m}$, $700\text{-}900\text{m}$, $900\text{-}1100\text{m}$, $1100\text{-}1900\text{m}$ and $>1900\text{m}$. For the cells in each elevation zone, the representative weather station was found with the construction of Thiessen polygons around the weather stations, situated in that zone. Station temperature was converted to cell temperature in the same way as described above. Records of at least three stations were available for each zone. This method reduces errors in temperature calculations during periods of temperature inversion. These periods occur particularly during winter periods in the Alps.

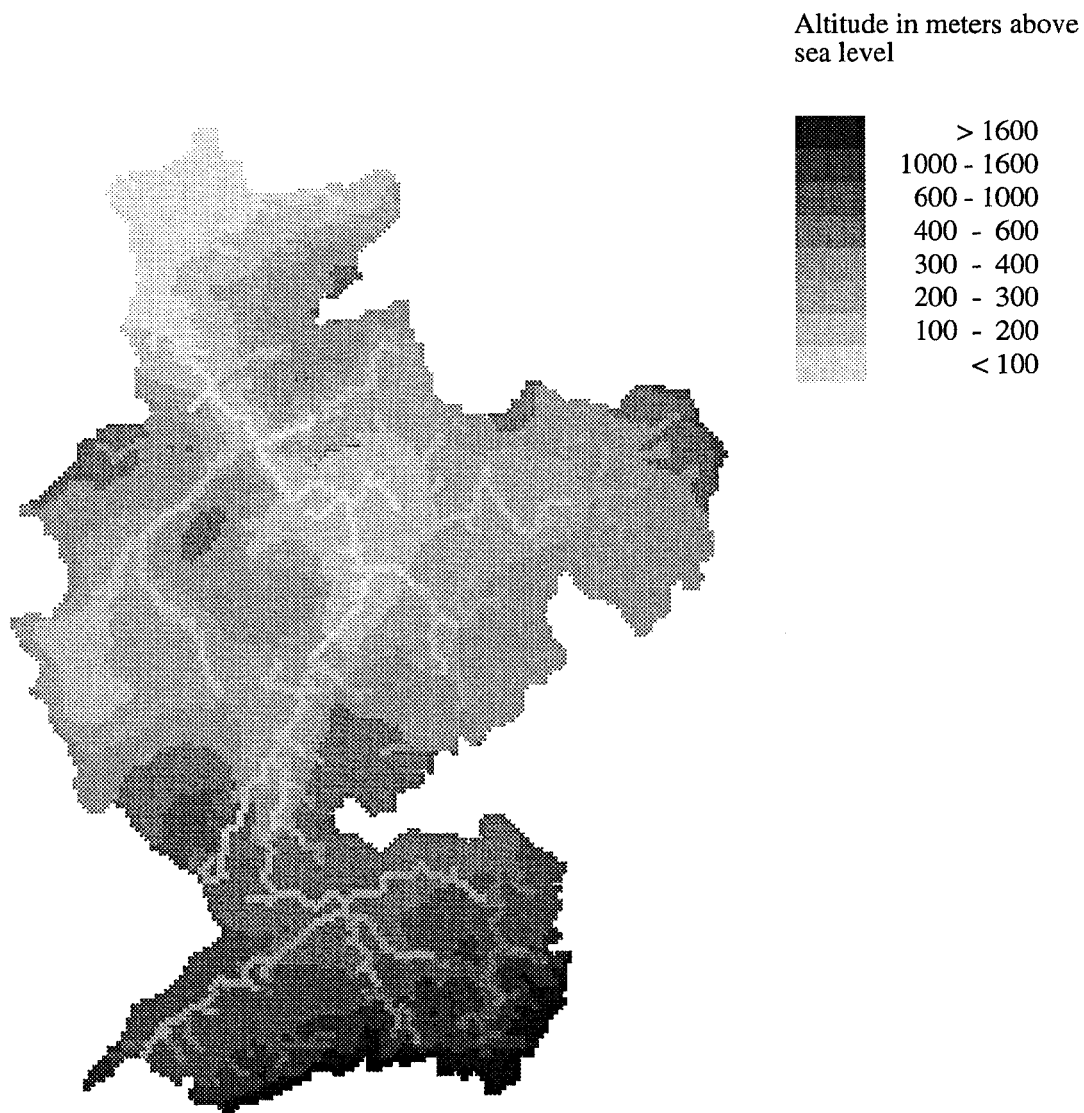

Figure 6 Digital Elevation Model (altitude in m.a.s.l.)

- *A Digital Elevation Model (DEM)*

This DEM was digitised from a contour map, scale 1:1.500.000, published by the Commission Hydrologique du bassin du Rhin, CHR/KHR (CHR/KHR, 1976). The digitised elevation map (fig. 6) was interpolated using an inverse distance method. The variance of the DEM is determined by the vertical resolution of the original map. The original map is a contour map having an equidistance dependent on the relief energy. The zonation used is <25m; 25-50m; 50-100m; 100-200m, 200-400m; 400-600m; 600-800m; 800-1000m; 1000-1500m; 1500-2000m; 2000-3000m; >3000m.

- *A soil map*

A soil map, scale 1:1,500,000, published by the Commission Hydrologique du bassin du Rhin, CHR/KHR (CHR/KHR, 1976) was digitised. This map distinguishes soil associations based on the FAO-UNESCO classification system. The map provides information about soil texture, prevailing relief, source rock and land use type. The soil type map was re-labeled into a maximum soil storage capacity map (SSmax.map) using published data (Groenendijk, 1989a, 1989b) (fig. 7). Maximum soil water capacities vary from 30 to 300mm depending on soil texture, rooting depth of the vegetation, stoniness of the soil and depth of the lithic contact. More detailed soil maps are available for several countries. However, these use different classifications, which are difficult to convert into the hydrological properties of the different soil types.

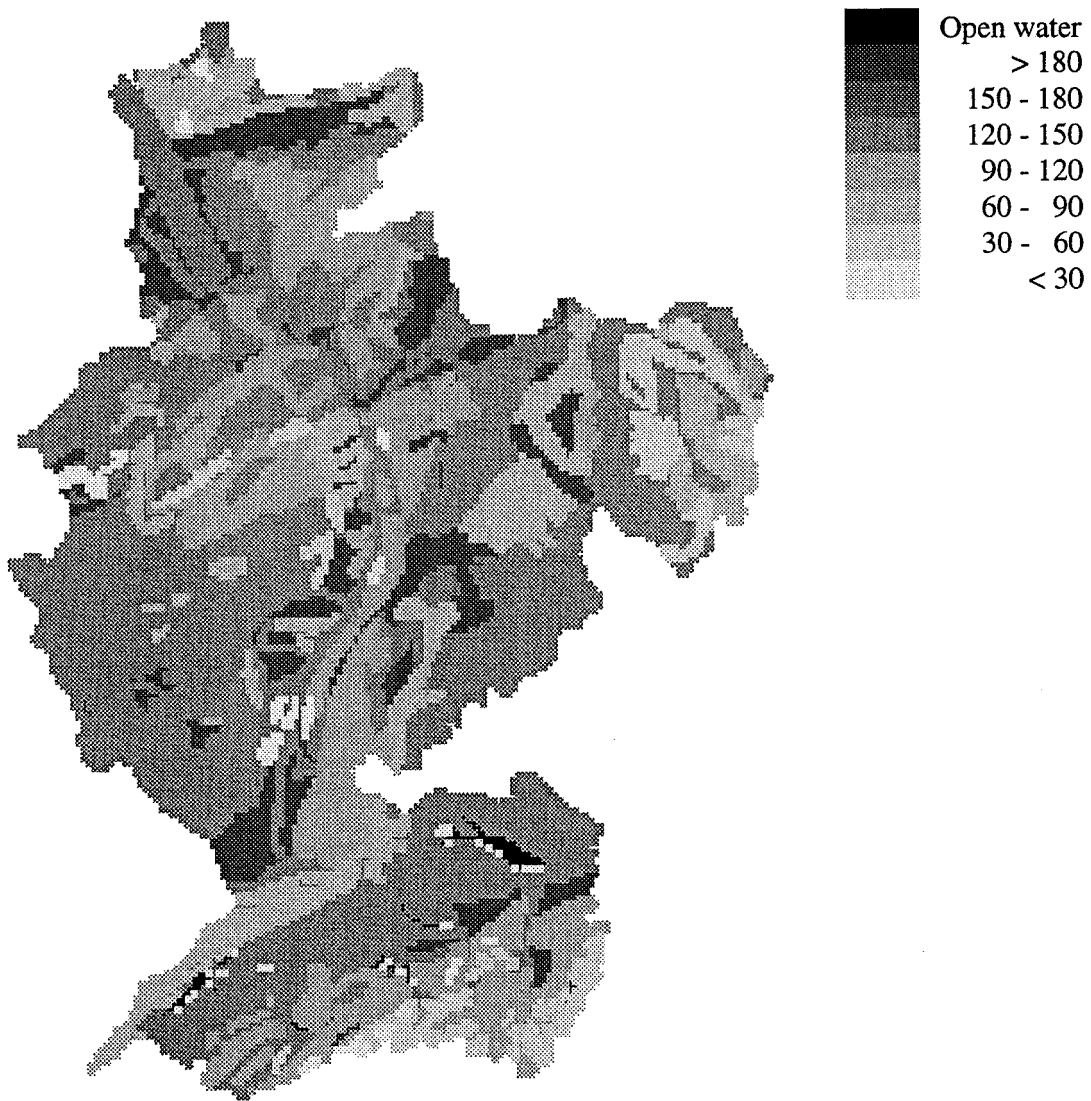

Figure 7 Maximum soil water storage capacity

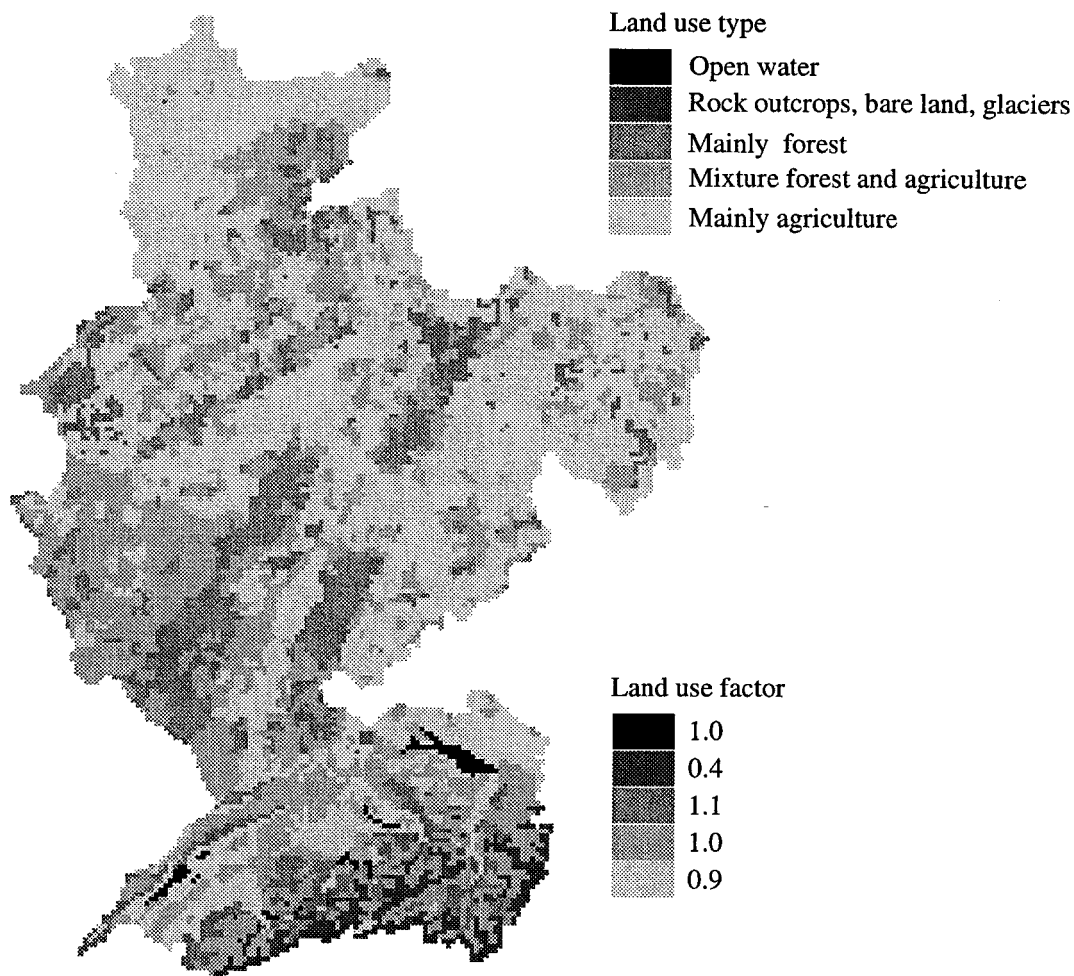

Figure 8 Land use map

- *A land use map*

A land use map, scale 1:1,500,000, published by the Commission Hydrologique du basin du Rhin, CHR/KHR (CHR/KHR, 1976) (fig. 8) was used. The original map distinguishes between the same land use type as presented in the legend of figure 8. This map was used since it provides a consistent interpretation of the different land use types for the entire basin. Although other data have recently become available, different countries use different classifications which are not easy to compare. The land use map was re-labeled into a land use factor map (fig. 8). This map was used to adjust the calculated potential evapotranspiration for different land use types.

- *Monthly changes in storage in natural and artificial lakes in the Alpine area*

Storage changes in lakes in the Alpine region affect monthly discharge variations (fig. 9). These changes are mainly determined by human management. Therefore, model calculations of discharge are corrected with existing data on monthly lake water storage variations in the main tributary catchments in the Alpine basin segment (tab. 3). Data is taken from a study of the water balance of Switzerland (Schädler, 1985) for the period 1900-1980. He estimated that errors in these data series were very small and could be ignored.

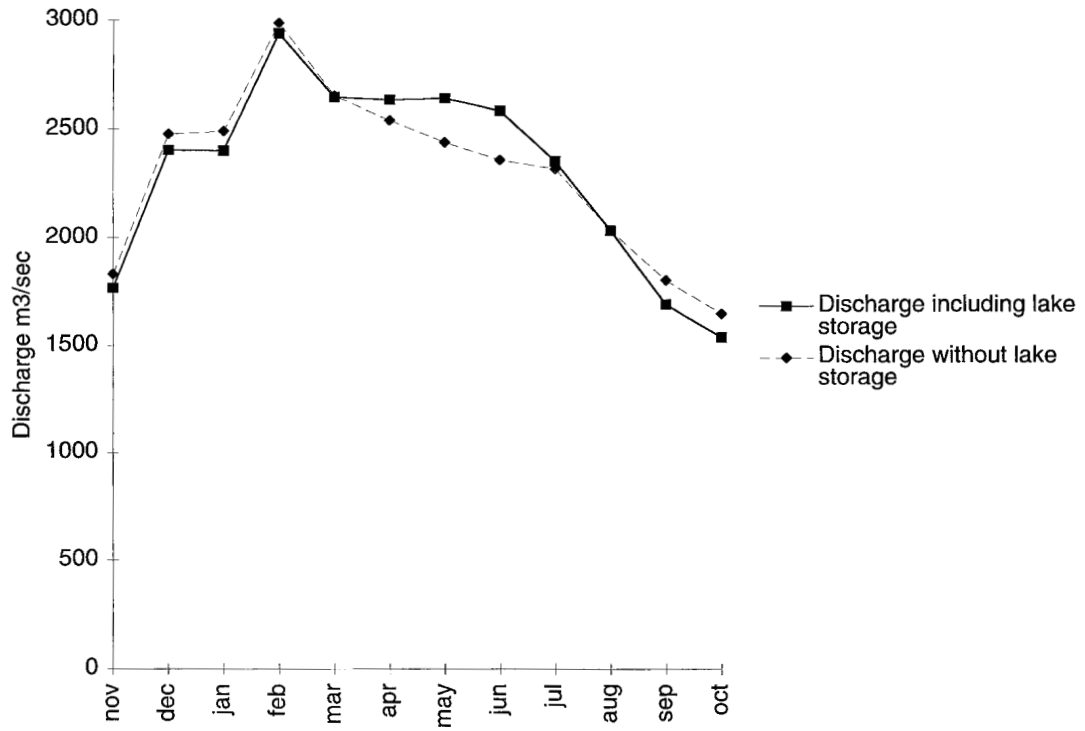

Figure 9 Effect of monthly lake storage variations on the discharge of the Rees gauging station

Time series used for model input			Time series used for calibration and validation			
Temperature station	Precipitation areas	Compensation for lake storage	Stations used for discharge validation	Stations used for snow storage validation (altitude m.a.s.l.)	Stations used for AE validation	
Germany:	Germany/France:	Upper Rhine:	Germany:	Switzerland:	Germany:	
Essen	1 Rees-Kaub	Aar	Rees	Klontal	860	
Bonn	2 Kaub-Maxau	Reus	Maxau	Guntlenau	860	Essen
Freiburg	3 Maxau-Rheinf.	Limmat	Rheinfelden	Sihlsee	895	Bonn
Giessen	4 Lippe		Cochem	Innerthal	910	Freiburg
Frankfurt	5 Lahn		Trier	Brandhalti	950	Giessen
Würzburg	6 Mosel		Kleinheubach	Rumein	1200	Frankfurt
Karlsruhe	7 Saar		Rockenau	Klosters	1200	Wuerzburg
Stuttgart	8 Nahe			Leyzin	1250	Karlsruhe
Friedrichsh.	9 Main			Flumserberg	1310	Stuttgart
Kissingen	10 Regnitz			Braunwald	1340	Friedrichsh.
Nurnberg	11 Neckar			Ulrichen	1345	Kissingen
Trier	12 Ill			Munster	1360	Nurnberg
				Kippel	1370	Trier
Switzerland:	Switzerland/Austria		Switzerland	Morgins	1380	
				Bedretto	1400	
				St Maria	1400	
Davos	13 Upper Rhine		Rheinfelden	Rigi-Klosterli	1410	
Saentis	14 Aar		Stilli	Sedrun	1420	
Basel	15 Reuss		Brugg	Andermatt	1440	
Altdorf	16 Limmat		Zürich	Splügen	1460	
Bern			Mellingen	Innerferra	1480	
Neuchatel				St Antonien	1480	
Arosa				Bosco Gurin	1490	
Chur				Moleson	1500	
Schaffhausen				Arosa	1500	
Einsiedeln				Montana	1500	
Chateaux d'oex				Fionnay	1500	
Langenbrueck				Davos	1560	
Langnau				Grindelwaldb.	1570	
Jungfrauoch				Garichte	1610	
Interlaken				Rigi-Scheidegg	1620	
				Zermatt	1620	
				San-Bernardino	1630	
				Mürren	1650	
				Stockhorn	1650	
				Bourg-St Pierre	1650	
				Zuoz	1710	
				La Drossa	1710	
				Fetan	1710	
				Zervreila	1740	
				Bivio	1770	
				Trubsee	1800	
				Maloja	1800	
				Barberinne	1820	
				Mauvoisin	1841	
				Hasliberg	1850	
				Robiei	1890	
				Buschalp	1980	
				Corvatsch	2273	
				Weisfluhjoch	2536	

Table 3 List of time series used

- *Average long-term changes in glacier storage*
 Estimation of annual water storage changes in glaciers requires yearly values for changes in the mass balance of the glaciers in all mountain catchments. Even in a well monitored country such as Switzerland annual mass balances are calculated only for few glaciers. Only for the Aletsch-glacier long-term time series exist for the annual mass balance. The Aletsch glacier is assumed to be representative over larger areas and therefore these time series are used to calculate changes in glaciers in other parts of Switzerland. This method may lead to unreliable results for single years. However, over decades the error is estimated to be smaller than 10%. Since annual data are not

reliable, glacier fluctuations are only taken into account for water balance calculations over decades. Seasonal fluctuations could not be taken into account. The effect of glacier fluctuations on the discharge may be large in small mountain catchments, however for the River Rhine at Basel, glacial melt has only increased average annual discharge by approximately 1% (Schädler 1985).

4.2 Calibration and validation time series

- *Monthly discharges for the main tributaries of the River Rhine and for 7 stations along the main river*

The longest time series used covers a period from 1870 to 1980, the shortest from 1956 to 1980. These discharge records were derived from the German Hydrological Office (BfG) and from the Swiss Hydrological Survey (BfL) (tab.3). At a gauging station discharge is calculated using water level in the river combined with a relation between the discharge and the water level (Q-h relation). This will lead to systematic errors if this relation has not been well established or the shape and size of the river bed changes due to erosion or sedimentation. However since the stations used are all major gauging stations for the River Rhine and its tributaries, the relations have been regularly verified. Therefore such errors will not be systematic but random errors. Schädler (1985) estimates an error of less than 1% over periods of years. This seems too low since different countries use different methods to determine discharge. This results in differences between measured discharge at gauging stations on either side the border. For the Dutch-German border the average discharge at the Lobith gauging station is approximately 100 m³/s (4%) less than that for the Rees gauging station, which is situated 25 kilometer upstream of Lobith. In this thesis it is assumed that these discharges are the same, and the time series of the Rees station have been taken for calibration and verification. Differences between Switzerland and Germany were ignored, since we have no discharge data for a station near the border on the German side.

- *Average monthly changes in snow water equivalents (SWE) for 30 mountain weather stations in the Alps*

These data were derived from the Geographical Institute at the ETH (Switzerland) (Martinez et al., 1992) (tab. 3). High altitude meteorological stations provide daily data on snow cover thickness. Since snow density may vary from 0.01 to 0.95 and densities vary strongly within the snow cover, these values are only of limited value to be used for estimations of SWE. Recently estimations for SWE for different stations in the Alps have become available. Estimations for areal SWE storage are still under concern (Rohrer, in press).

- *Average monthly evapotranspiration for different crop types*

Monthly totals of evapotranspiration for different crop types are provided by the German meteorological Office (DWD) for agricultural purposes (tab.3). In this thesis averaged monthly totals for evapotranspiration of grass are used for the period 1951 to 1980. The potential evapotranspiration is estimated using the method of Haude. This method calculates evaporation as a function of the maximum air moisture, actual air moisture and crop type, assuming that there is no water limitation for the plants.

4.3 Considerations for the use of the 3*3 kilometres grid size.

The choice of the spatial resolution of a 3*3 km grid is the result of several, mostly pragmatical, considerations. First of all, it is important to note that the grid resolution used, is certainly not the resolution at which the model results can be reliably evaluated. This restriction is mainly determined by the used data set for areal (tributary) precipitation. The use of areal precipitation does not take spatial variability of the precipitation within the area, into account. For individual cells or small catchments within these areas, this input variable may be under- or over-estimated, which will inevitably lead to errors in the water balance calculations. With this data set no quantitative estimation can be produced for this error. However, it will be largest in mountain areas, where large variations in precipitation exist over small distances. Since the precipitation areas correspond with the main tributaries of the River Rhine, this is the highest resolution at which one can expect reliable model results.

The considerations for the spatial resolution choice concern both accuracy of the input data and generalisation problems when new data is converted into the data base:

- The resolution of all base maps should be the same, thus avoiding problems with generalisation and interpolation due to differences in grid size. The resolution should allow for the mapping of all spatial detail.
- Topographical data was derived from maps with a scale of 1:1,500,000. On these maps 3 km is represented by 2mm, which is assumed the maximum detail of the spatial information of these maps. Using a finer grid size would introduce a fake spatial accuracy of this information. These maps were the most detailed maps available covering the whole Rhine catchment.
- Station temperature was converted to cell temperature data by constructing a Thiessen polygonal net around the weather stations. Using a fine grid permits a fairly accurate delineation of these Thiessen polygons.
- The model is designed for the use on a personal computer (PC). Using this resolution a model run for 25 years takes 6 hours on a present-day PC (IBM-PC with a 80386 processor and co-processor and 8mb extended memory). This was thought to be the upper limit for computing time.
- The model is designed to estimate the impact of climate change. The most recent scenarios for climate change, produced by climate models, use a spatial resolution of 3.75 degrees latitude and 2.5 longitude. These scenarios have been interpolated onto a finer grid (0.5 degree latitude and 1 longitude) using present day climate information (Climate Research Group, University of East Anglia (CRU) and Environmental Resources Limited, unpublished data). The climate scenarios produced on this fine grid by the CRU, will be used as input data for analysis of impact of climate change on the River Rhine. The use of the 3*3 square kilometres grid allows for an accurate delineation of the grid for which the climate scenarios are produced. In turn this permits quick and easy manipulation of input data to analyse future scenario results in space and time.

The use of the 3*3 kilometres grid size clearly introduces limitations, above all concerning slope determination:

- Calculations of slope gradient and exposition for drainage delineation from a DEM with a 3*3 km resolution do not have any physical meaning. Therefore, an accurate estimation of local overland flow direction is not possible with this modelling concept. Using this resolution there is no physical background to separate horizontal water flow into direct and delayed runoff. Hence, flows such as Hortonian overland flow and saturated overland flow are not incorporated into the model. The separation of the different flow types may only be possible on small scale plots (e.g. Ward and Robinson, 1990). For the River Rhine, therefore, runoff is proportionally separated into quick and delayed runoff.
- More physically-based models to determine snow-melt and snow accumulation cannot be used since these also depend strongly on local slope exposition.
- Since the width of river channels in the Rhine basin is less than 3 km, the drainage analysis does not make any statements about the nature (braided, meandering or anastomosing) of the channels. Cells located in the river sections (see fig. 11 and 12) do not imply that the river is actually 3 km wide, but the location of a cell in a river section means only that there is a flow path through that cell.

Two remarks must be made with respect to these limitations.

Firstly, the model has been developed to analyse the discharge of the River Rhine and the major tributaries on a monthly time basis. Using this time basis and a catchment scale the contribution of different flows (saturated and Hortonian overland flow, inter flow and groundwater flow) to the stream flow may not be relevant.

Secondly, the concept the runoff is calculated assumes that all water available for stream flow in the large tributaries will leave the catchment within one time interval. Therefore the model has not been developed to incorporate any in-channel processes, such as hydraulic routing. Consequently, the nature of the channels is not relevant.

5 IMPLEMENTATION OF THE GIS DATA BASE INTO THE WATER BALANCE MODEL USING THE WATERSHED TOOLS

Following the listed procedures in section 2, the section the steps to implement the GIS data base into the water balance model are described. The WATERSHED tools provide the modules TIMEINP, CALC, WATERSH, ACCU, CMODEL, TIMEOUT and DISPLAY to carry out the procedures for this implementation.

Procedure 1. Read input data for a certain location (x,y) and time step (t).

This procedure is carried out by reading temperature data and precipitation data (stored in table files) and convert them into raster maps using identifier (ID) maps (fig 10a and b). The map that constitutes the Thiessen polygons (t_stat.id) is the ID map for temperature. These polygons were labelled with integers 1 to 27, corresponding with the sequence of the stations in the table file. For precipitation the tributary catchments and river sections, for which monthly areal precipitation were known, have been determined using the drainage pattern map. Each section was labelled and stored in the 'p_area.id' map.

For each time step the module TIMEINP reads the data sequentially from the data file and stores it into these maps. This requires the following command line:

```
TIMEINP temp.map = t_stat.id, temp.dat, timer
```

```
TIMEINP prec.map = p_area.id, prec.dat,timer
```

in which

temp.map = the resulting map for temperature
prec.map = the resulting map for precipitation
t_stat.id = the map containing the 27 thiessen polygons, numbered 1-27
p_area.id = the map containing the precipitation areas
temp.dat = the data file containing time series of monthly temperature data from 27 stations. These stations are ordered column-wise, each row corresponds with a month
prec.dat = the data file containing the time series for areal precipitation. The areas are ordered columnwise, each row corresponds with a month
timer = determines which time step is carried out. If the timer is 1 the TIMEINP module reads the first row of the data file, if TIMER is 2 the second etc.

Original map

Raster map

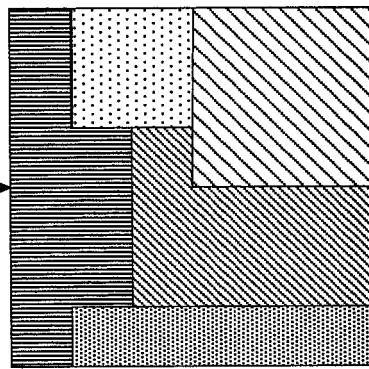
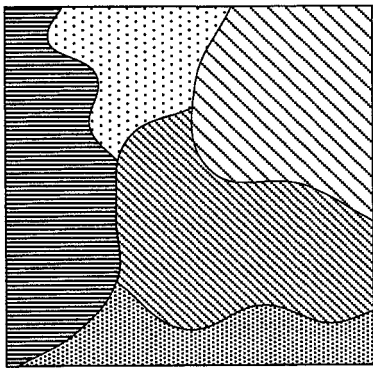

1	2	2	3	3	3
1	2	2	3	3	3
1	2	2	3	3	3
1	1	4	4	4	4
1	1	4	4	4	4
1	5	5	5	5	5

Figure 10a Conversion from an original (hard copy) map to a raster (digital map)

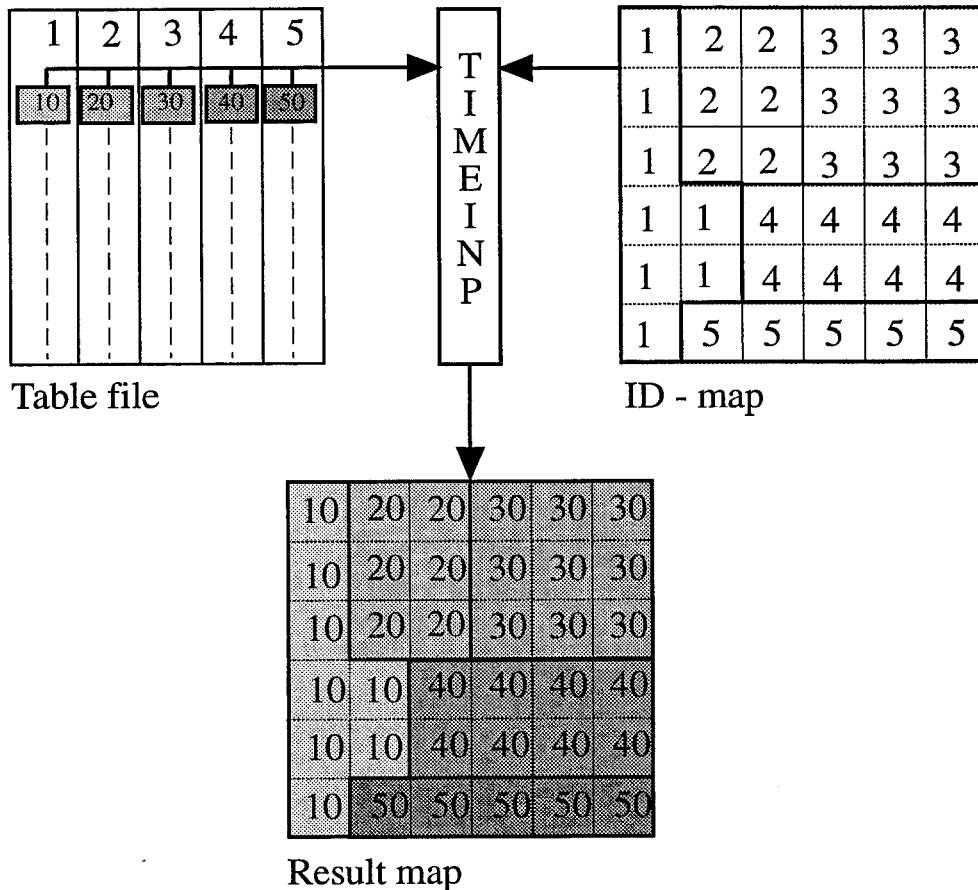

Figure 10b conversion from time series data into raster maps using the TIMEINP module

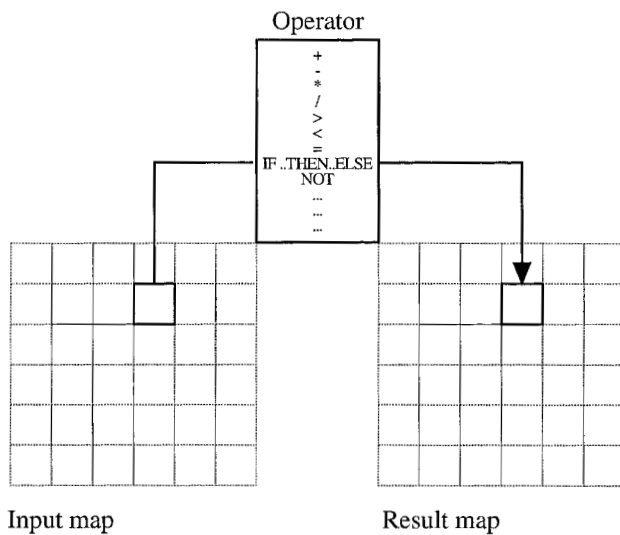

Figure 11a Raster map calculations using one input map with the CALC module

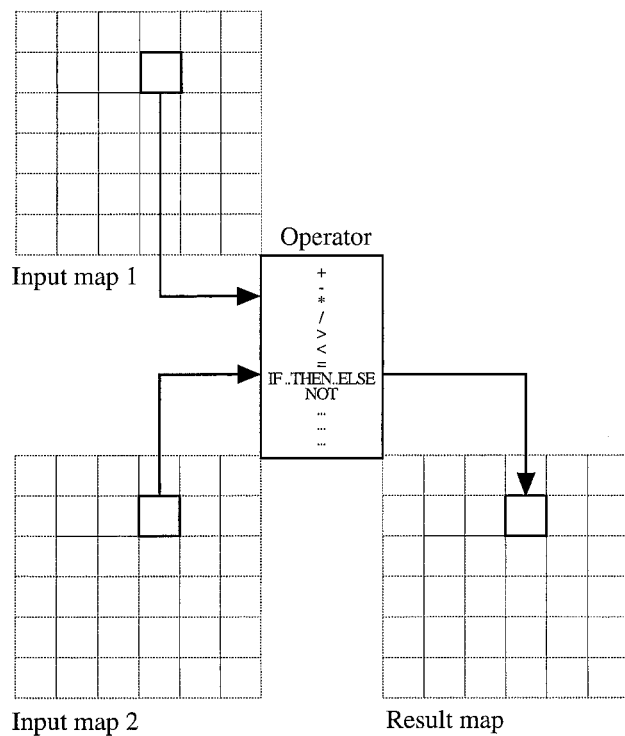

Figure 11b Raster map calculations using more maps with the CALC module

Procedure 2. Carry out the necessary calculations to determine the water balance at (x,y,t) from the initial conditions at (x,y,t-1) and the new input data.

For procedure 2, the water balance at a location (x,y) must be calculated. This requires a raster map calculator. In the WATERSHED tools this is the CALC-module. This module can evaluate almost any arithmetical point-operation on gridded map-data (fig. 11a and b). It has a list of built-in functions, such as LN (natural logarithm), SQRT (square root), which can be applied to the raster maps. Logical functions can be implemented with MIF (IF Map ... THEN ELSE....) using operators LT (less than), GT (greater than), EQ (equals). For example the operation to determine the location and amount of snowfall and snow cover is written as follows:

```

CALC snow.map = MIF(temp.map GT 0 THEN 0 ELSE, prec.map)
CALC rain.map = prec.map-snow.map
CALC cover.map = cover.map + snow.map

```

in which

- snow.map = the resulting map showing the location and amount of snowfalling during the month of concern (depending on the cell temperature determined from temp.map); the cells in snow.map will have a positive value, depending on the amount of precipitation, if the cell temperature is equal or lower than 0 degrees Celsius, and a value '0' if cell temperature is higher than 0 degrees Celsius.
- prec.map = the map that contains the areal precipitation,
- rain.map = a map that shows the location and amount of precipitation falling in form of rain; cells in this map contain value '0' if the temperature of the cell (from temp.map) is below 0 degrees Celsius and will have a positive value, depending on the amount of precipitation (prec.map) if the cell temperature is above zero.
- cover.map = a map which contains the amount of water stored in the snow from the preceding time step. This map is replaced by the new cover.map onto which the actual snowfall (snow.map) is added to the snow cover from the previous time step. In this example snow-melt is ignored. However, RHINEFLOW does include statements to calculate snow-melt (fig. 15).

Procedure 3. Determine the spatial connectivity between the cell (x,y) and the outlet of the catchment.

The spatial connectivity between all the cells and the outlet is determined using the program WATERSH. This program enables the user to extract drainage patterns from elevation data and use these patterns for the geomorphologically based routing modules. The drainage direction for each cell is stored in a Local Drain Direction matrix (LDD). The basic concepts for drainage pattern analysis were taken from published descriptions of recursive basin delineation given by Marks et al. (1984) and publications by Jenson and Domingue (1988) and Morris and Heerdegen (1988). The WATERSH program includes procedures to handle 'flats' and 'pits'. Flat elements are recognized where the lowest neighbour of any element at the centre of the 3 x 3 window has the same eleva-

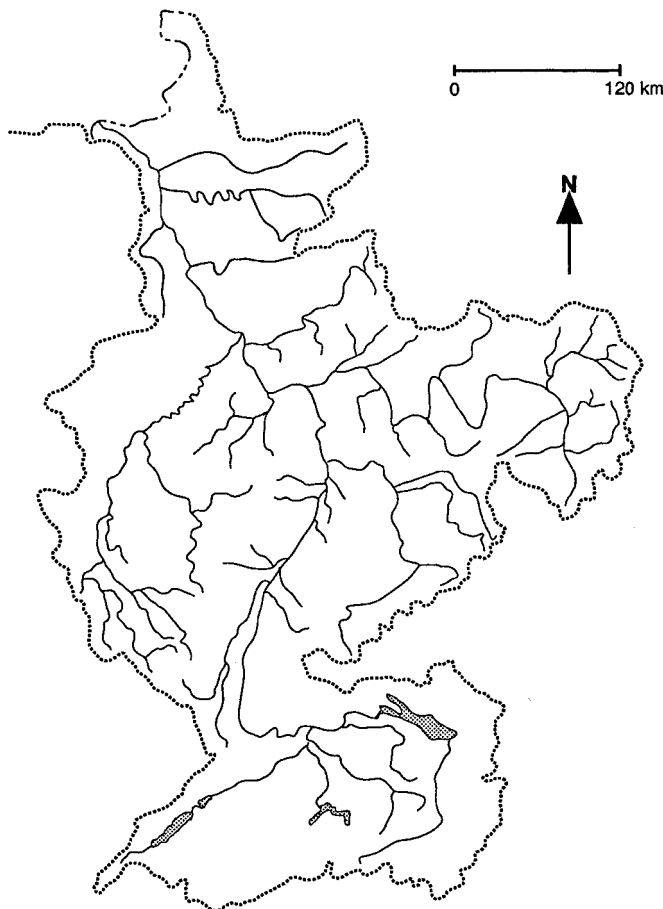

Figure 12 Observed drainage pattern

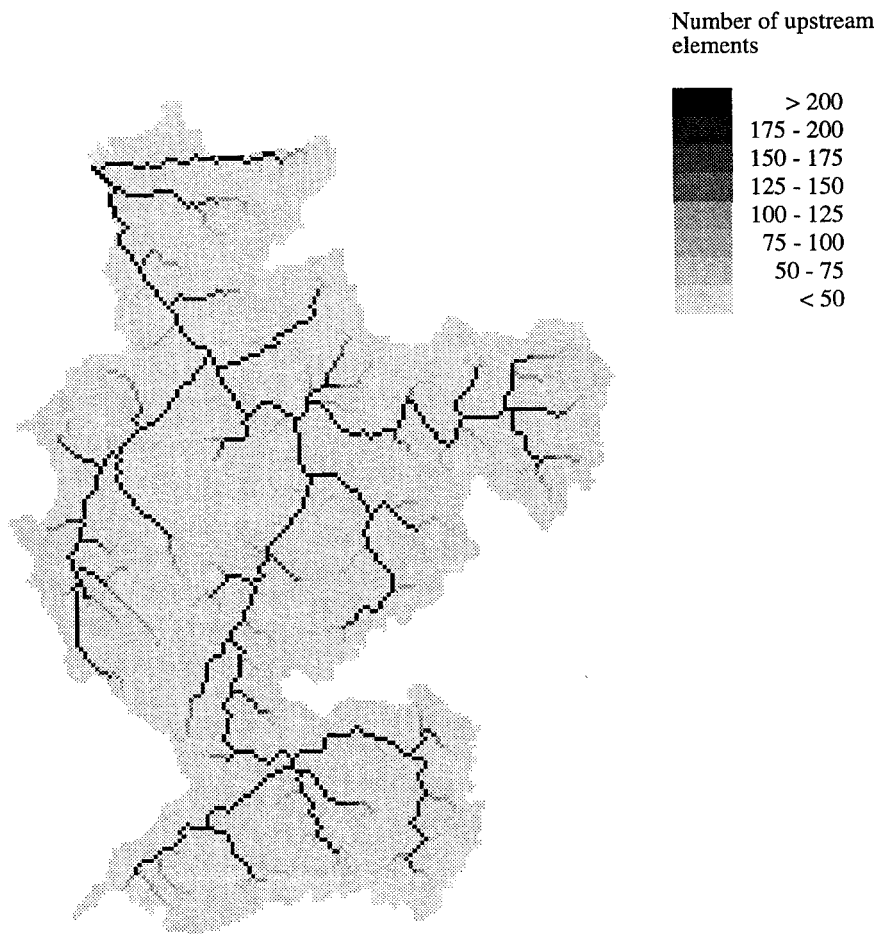

Figure 13 Calculated drainage pattern (number of upstream elements)

tion as the central element. Pits are those grid elements surrounded entirely by elements of higher elevation. The approach followed is discussed extensively in Van Deursen and Kwadijk (1990, 1993) and Van Deursen (in prep).

The results of the geomorphological routing are presented in figure 12 and 13. These show the observed and calculated drainage pattern. Table 4 presents the calculated and measured size of the sub-drainage basins. Both show that the approach produces acceptable results both for the pattern and for the size.

Drainage basin	DEM (%)	Measured (%)
Lippe	4.8	3.1
Ruhr	2.5	2.8
Lower Mosel	2.9	2.7
Upper Mosel	10.9	10.3
Saar	3.1	4.6
Lahn	3.2	3.7
Nahe	2.2	2.6
Main	17.4	17.0
Neckar	7.7	8.8
Ill	2.0	3.01
Upper Rhine	9.2	10.0
Aar	7.3	7.4
Limmat	1.8	1.3
Reuss	7.3	7.4

Table 4 Measured size in percentage of the entire basin and calculated size of the sub-drainage basins using the digital elevation model (CHR/KHR, 1976)

Procedure 4. Carry out the calculations to determine the discharge at the outlet of the catchment(s), based on the spatial connectivity.

In procedure 4 water is routed through the local drain direction matrix (LDD). The module ACCU carries out this routing. In a water balance model such as RHINEFLOW the input map for this module contains water available for runoff (delayed and direct flow) calculated for each cell. The output map will contain the available water accumulated through the Local Drain Direction Matrix (fig. 14). In the model this is written as:

$$\text{ACCU streamf.map} = \text{runoff.map, LDD.map}$$

in which

streamf.map = the resulting map. In this map a cell value represents the accumulated runoff of all the cells upstream of that cell.

LDD.map = the Local Drain Direction map.

runoff.map contains the water available for runoff calculated for each cell.

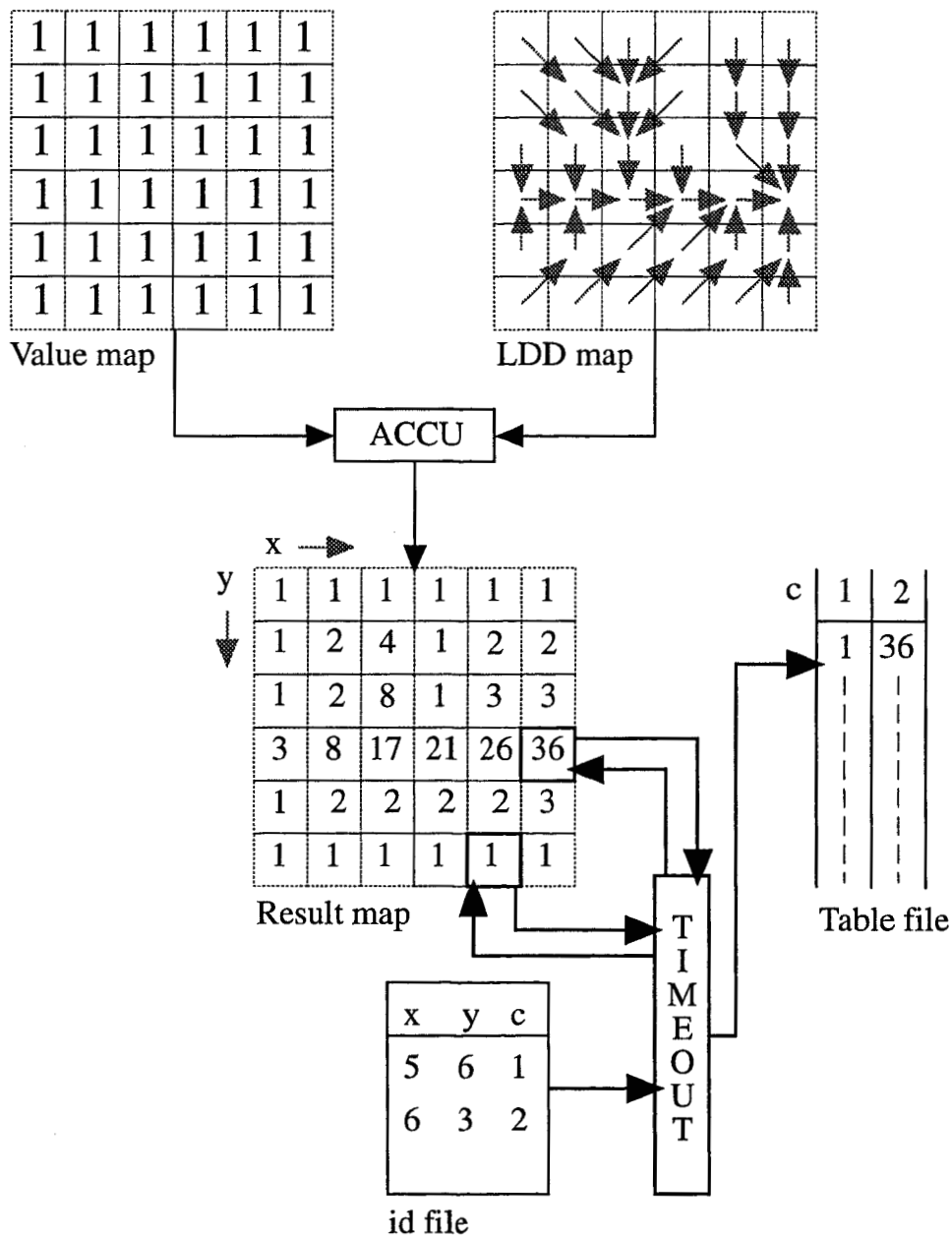

Figure 14 Calculation of catchment runoff using the ACCU module and conversion of results, stored in raster maps, to table files using the TIMEOUT module

Procedure 5. Produce output data series or maps, to enable others (users or models) to use the results of the model.

To create output time series for a selection of cells the coordinates (x,y) of these cells are stored in a table file. In this table file the selection is ordered rowwise. The module TIMEOUT reads the value of the selected cells in the raster map and writes the cell values sequentially to a data file (fig. 14). In this data file the value of the first selected cell is written in the first column, for the second cell in second column etc. For example, pe.map contains calculated evapotranspiration values:

TIMEOUT pe.dat = pe.map, output.id, timer

in which

pe.dat = the resulting data file
 pe.map = the evapotranspiration map
 output.id contains the x,y coordinates for a selection of cells
 timer determines to which row the output value is written to.

A module that allows visual evaluation of the results is DISPLAY, which is used for display of raster maps created by the model.

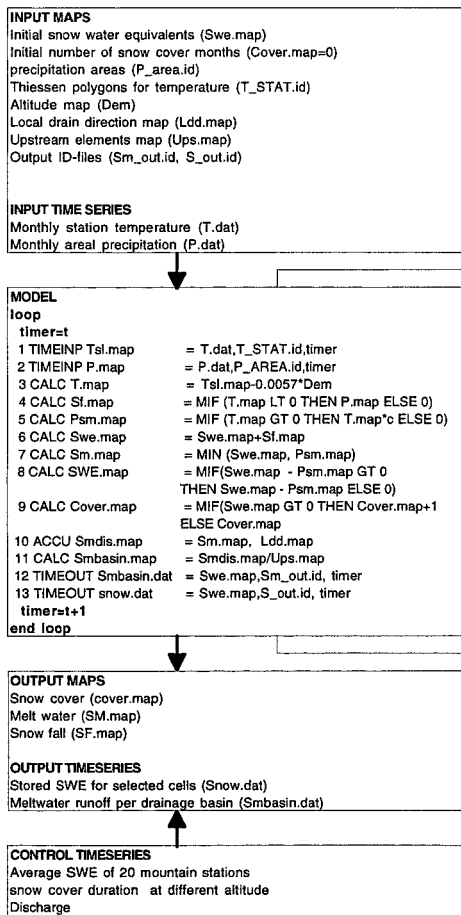

Figure 15 Calculation of snowfall and snow-melt using the WATERSHED tools

OPERATION	MODULE	PROCEDURE
1 Temperature (at sea level) data file is converted into a temperature map	TIMEINP	1
2 Areal precipitation data file is converted into a precipitation map	TIMEINP	1
3 Cell temperature = temperature at sealevel- (altitude temperature coefficient * altitude)	CALC	2
4 IF temperature > 0 Celsius THEN snowfall = precipitation ELSE snowfall = 0	CALC	2
5 IF temperature > 0 Celsius THEN potential snowmelt=temperature * meltrate ELSE snowmelt = 0	CALC	2
6 Snow Water Equivalents = initial Snow Water Equivalents + Snowfall	CALC	2
7 Snowmelt = minimum of Snow water equivalents or potential snow melt	CALC	2
8 IF Snow Water Equivalents > Potential snow melt THEN Snow Water Equivalents = Snow Water Equivalents - Potential Snow melt ELSE Snow Water Equivalents=0	CALC	2
9 Snow cover duration is calculated (snow cover duration +1 month if SWE > 0)	CALC	2
10 Total basin meltwater production = melt water production in a cell and its upstream elements	ACCU	4
11 average basin meltwater production = total meltwaterproduction/size of the basin	CALC	2
12 Snow melt water per drainage basin is written to data file	TIMEOUT	5
13 Snow water equivalents in selected cells in this timestep (month) is written to a data file	TIMEOUT	5

Procedure 6. Carry out the water balance calculations repeatedly in order to model dynamically and to produce time series as a result.

To model one time interval all equations must be successively solved. For this purpose a command file can be created which contains all operations of the model in the correct sequence. To calculate one time interval this command file is executed. Within one time interval the resulting map of a previous equation can be the input map for a following operation.

Dynamic modelling, which implies that the results of previous time step are used as the input in the next, requires a simple program that allows the command file to be carried out repeatedly and increase 'timer' with one for every successive time step. This is done by the module CMODEL. For example the command line:

```
CMODEL model.txt 1 3
```

executes the command file 'model.txt'. The integer 1 determines that the TIMEINP starts reading the first line of data files. The integer 3 determines that the execution will stop after 3 time steps.

Figure 15 illustrates the sequence of GIS operations necessary to model the snow accumulation and melt, in the RHINEFLOW model.

6 CALIBRATION AND VALIDATION OF THE MODEL

6.1 Discharge representation

For calibration and validation of the RHINEFLOW model, we used a split sample of a wet and a dry period as proposed by Klemes (1986). Consecutive time series for discharge for all major tributaries have not been available for before 1956. Therefore the model was calibrated by comparing the calculated and observed hydrographs from the relative wet period November 1965 to October 1970. Depending on the tributary, in this period the sub-basins received 10-20% more precipitation than the average from 1956-1980. The calibrated model was validated for the period from November 1956 to October 1980. Figure 16 shows the hydrographs for Rees, Rheinfelden, Cochem and Rockenau. Rees represents the entire basin up to the German-Dutch border, Rheinfelden represents the Alpine area, Cochem (Mosel) the 'Mittelgebirge' area and Rockenau (Neckar) the 'Schichtstufen' area (see section Introduction). The figure shows that the calculated discharge fluctuations reasonably represent the observed discharge over longer time periods. The model performs quite well both for the calibration period and for the verification period for the tributaries as well as for the main river. Table 5 shows the annual representation of the discharge of different basins.

These findings are supported by statistical analyses of the model results against observed values (table 5). The performance of month to month discharge variations was tested with the coefficient of efficiency (Nash and Sutcliffe, 1970). This coefficient reflects the goodness of fit of the calculated hydrograph. A value of 1 represents a perfect fitting curve, values less than zero imply that the mean is a better representation than the model result (table 5).

Gauging station	River	Area (km ²)	Average annual discharge (OBS,m ³ /s)	Average annual discharge (CALC,m ³ /s)	Standard deviation (OBS)	Standard deviation (CALC)	Coeff. of efficiency
Rees	Rhine	entire basin, 160000	2300	2264	1003	907	0.77
Maxau	Rhine	basin, 50196	1269	1162	544	442	0.71
Cochem	Mosel	middle-lowland, 27000	300	301	247	244	0.81
Mettlach	Saar	middle-lowland, 5700	74	72	62	60	0.78
Kleinheub.*	Main	middle-lowland, 21505	155	169	110	100	0.76
Rockenau	Neckar	middle-lowland, 14000	127	130	87	79	0.74
Rheinfelden	Rhine	alpine, 34550	1027	1022	482	453	0.75
Stilli	Aar	alpine, 17000	556	570	266	253	0.74
Mellingen	Reuss	alpine, 3382	139	133	83	76	0.77
Zürich	Limmat	alpine, 2176	96	99	57	51	0.72

* tested for the period 1959-1980

Table 5 Model results for different drainage basins for the test period 1956-1980

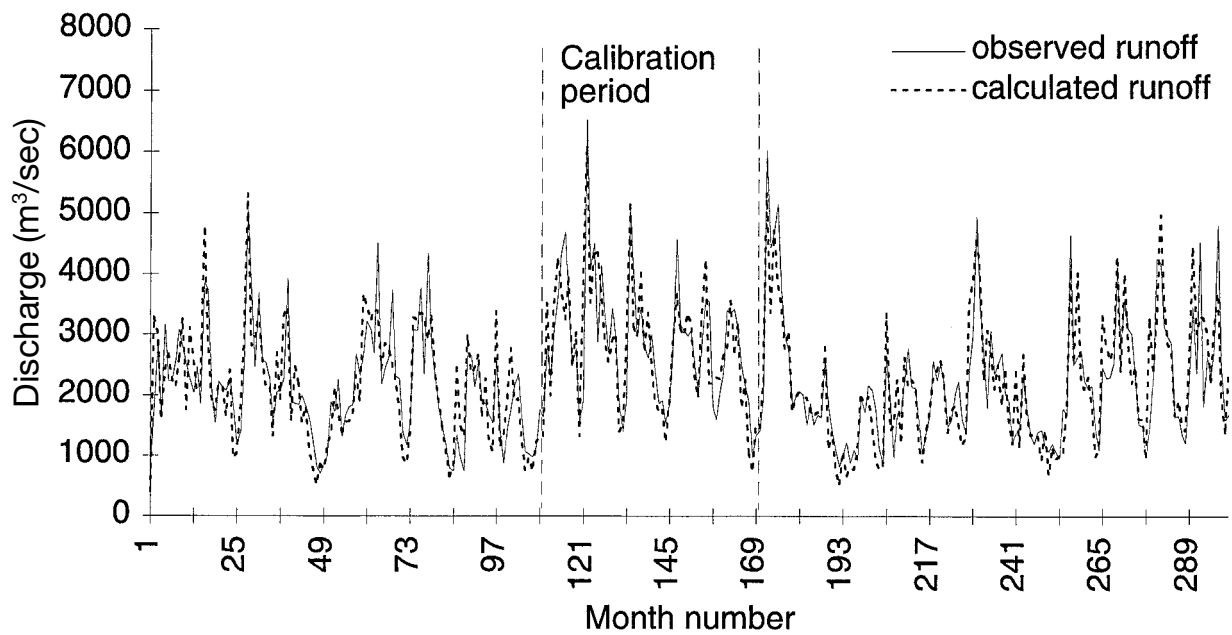

Figure 16a Observed and calculated discharge for the Rees gauging station. Period November 1956 – October 1980

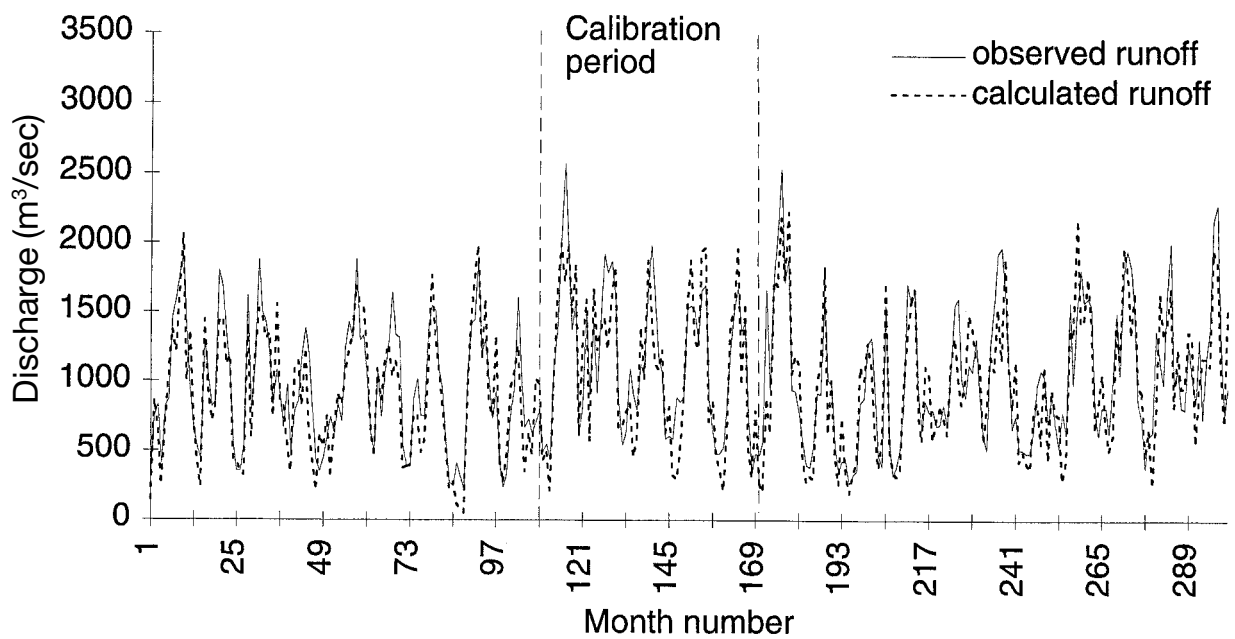

Figure 16b Observed and calculated discharge for the Rheinfelden gauging station (Alpine part of the River Rhine basin). Period November 1956 – October 1980

Analysis of the performance on a monthly time basis in the Alpine basin shows that the model calculates discharge slightly too low during winter and summer and too high during autumn. Although the model shows the highest model efficiency for the river Mosel, discharge of this river is slightly under-estimated during dry periods. In section 8 these model errors will be discussed.

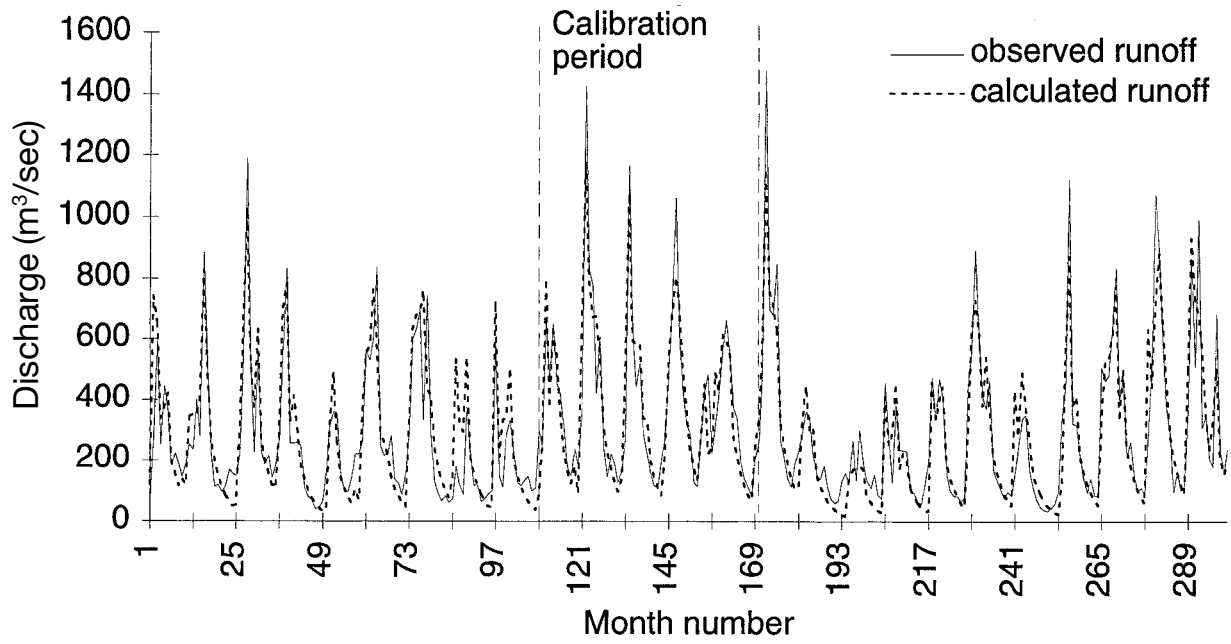

Figure 16c Observed and calculated discharge for the Cochem gauging station (River Mosel). Period November 1956 – October 1980

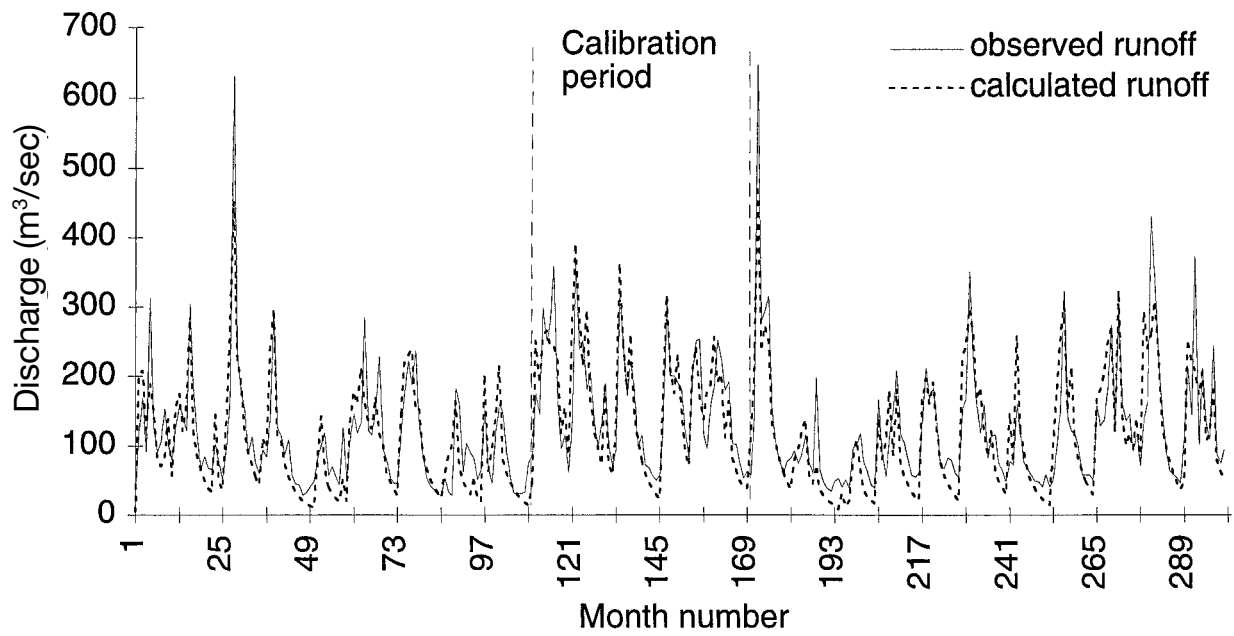

Figure 16d Observed and calculated discharge for the Rockenau gauging station (River Neckar). Period November 1956 – October 1980

6.2 Validation of the evapotranspiration calculations

The average calculated monthly actual evapotranspiration is compared with data on the average amount of evapotranspiration (fig. 17). These data comprises calculated potential evapotranspiration using the method of Haude published by the DWD, actual monthly evapotranspiration for the Mosel basin Keller (1958), and monthly actual evapotranspiration for the Alpine basin section based on water balance calculations (Baumgartner et al. 1983; Schädler 1985). The model results fit well with the data for actual evapotranspiration in the German/French section of the basin. The model simulations for actual evapotranspiration are lower than the potential evapotranspiration as calculated by Haude, which is reasonable since evaporation losses during summer are lower than the potential losses due to soil water deficits. In the Alpine area the model slightly under-estimates the evapotranspiration during the summer period, which may have led to the over-estimation of the autumn discharge. The model also over-estimates the evapotranspiration during the winter period.

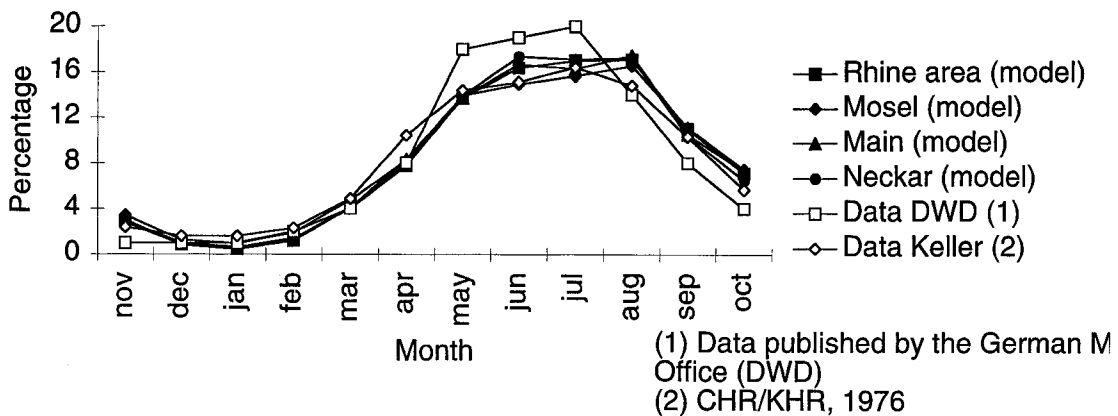

Figure 17a Model calculations and published data for average monthly areal evapotranspiration for Germany (in percentage of the annual total evapotranspiration)

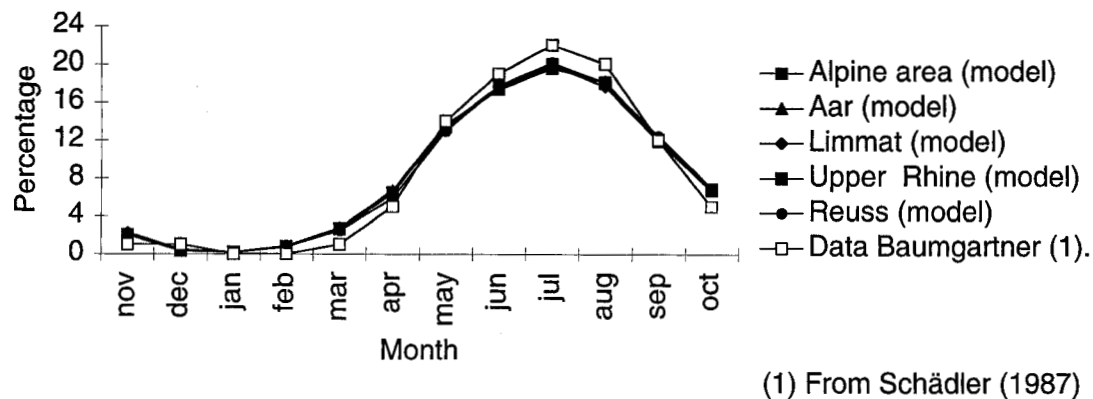

Figure 17b Model calculations and published data for average monthly areal evapotranspiration for the Alpine area (in percentage of the annual total evapotranspiration)

6.3 Validation of the snow cover and snow storage calculations

The calculated snow water equivalents (SWE) at different altitudes were compared with the averaged observed values between November and June for different stations. The model results are within the observed range for altitudes between 750 and 1600 meters. Figure 18 shows the results for the altitude range between 750 and 1350 meters. The figure shows that even average monthly SWE are highly variable for different stations. Timing and amount of the calculated maximum SWE storage are found satisfactorily. The calculated final decay of the snow cover is somewhat (approximately one month) too late. Above 1600m the model calculates too little snow-melt during the late spring. This leads to an underestimation of the summer discharge in the Alpine region. Since the area above this altitude is relatively small the resulting error in the calculated discharge is also small.

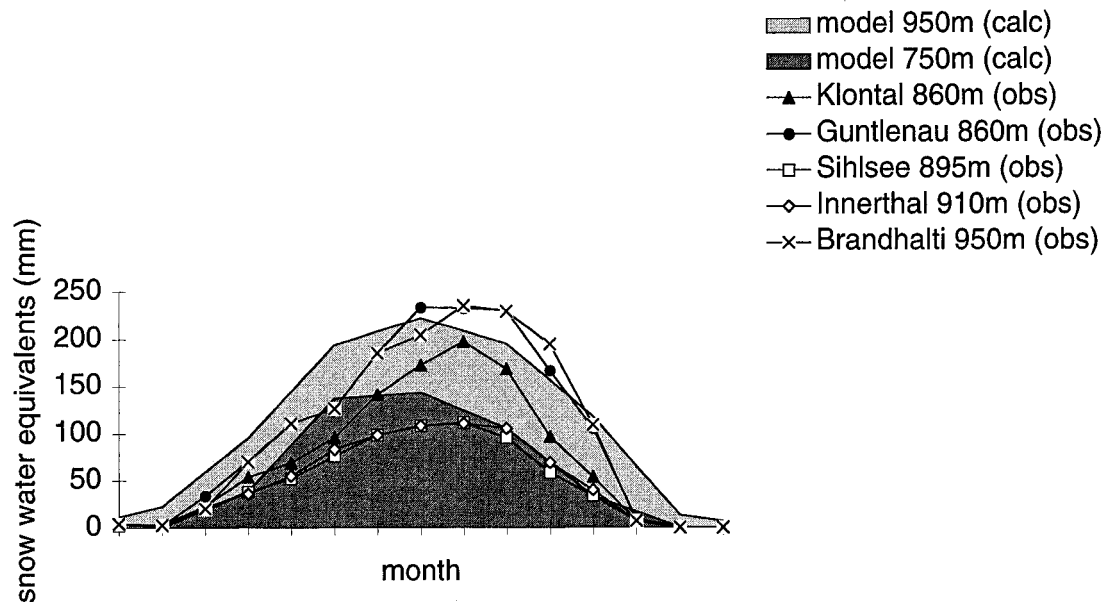

Figure 18a Calculated and observed average amount of water stored in the snow (SWE) between 750 and 950 m.a.s.l. in the Alpine area

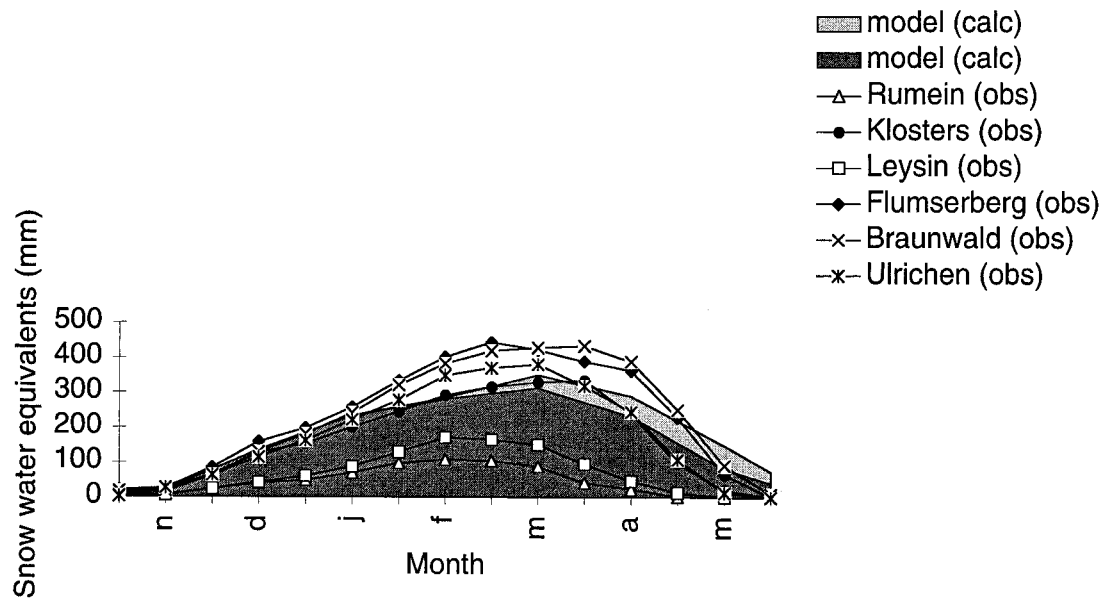

Figure 18b Calculated and observed average amount of water stored in the snow (SWE) between 1150 and 1350 m.a.s.l. in the Alpine area

6.4 Sensitivity of the separation and recession coefficients

No data is available about storage in the soil and deeper compartments over larger areas. Therefore, contrary to the snow storage and the evapotranspiration module, soil water and groundwater storage modules cannot be independently controlled. We therefore investigated the sensitivity of the model results for changes in the parameters that determine the direct and delayed flow from the soil and groundwater compartment to the river. Obviously, a model that is sensitive to (small) changes in parameters, that influence modules that cannot be validated with observed values, is less reliable. This is particularly the case, if the model is developed to be used under conditions that may alter these parameters.

The separation coefficient (α) and the recession coefficient (C) determine the flow from the soil- and groundwater storage and therefore the shape of the hydrograph. A series of model runs was carried out to investigate the sensitivity of the model results for different values of these parameters. Each model run used another combination of parameter values. This investigation also gives information

about the interdependence of both parameters. These parameters are highly dependent if different combinations of parameters produce the same calculated discharge. This would imply that the separation into the two compartments soil water and groundwater storage, as used in the model, is not justified.

Table 6 shows some results for the river Mosel and river Reuss. These results are representative for the other areas. These data show that model efficiency is little sensitive to changes in both parameters. They also show that different parameter combinations can give the same model efficiency. However, maximum model efficiency is centred around one combination of C and x.

From these findings one can conclude:

- that variations in the recession and separation coefficient have only a minor effect on the model results.
- Both parameters seem to be independent since maximum model efficiency as shown in table 6 is centered around one set of C and x. This justifies the concept used of separation between rapid and delayed flow.

a. Mosel basin (FRG)											
	x	0.00	0.10	0.15	0.20	0.25	0.30	0.35	0.50	0.75	1.00
c											
1.00		0.12									0.12
1.50		0.60	0.57	0.55	0.54	0.52	0.50	0.47	0.40	0.25	
2.00		0.73		0.73	0.71	0.70	0.67	0.65	0.56	0.35	
2.50											
3.00	0.80	0.80			0.81	0.82	0.80				
3.50											
4.00	0.68	0.76	0.79	0.81	0.82	0.82	0.81	0.81	0.76		
4.50	0.64	0.76	0.77	0.79	0.81	0.82	0.82	0.82	0.77		
5.00	0.60	0.71	0.75	0.76	0.80	0.81	0.81	0.82	0.78		
5.50	0.56	0.68	0.73	0.76	0.79	0.81	0.81	0.81	0.78		
6.00											
6.50	0.50	0.64	0.69	0.73	0.77	0.80	0.79	0.79	0.79	0.56	
7.00											
7.50											
8.00											
8.50	0.41	0.57	0.63	0.68	0.73	0.76	0.78	0.78	0.78	0.57	
9.00											

b. Reuss basin (CH)											
	x	0.00	0.10	0.15	0.20	0.25	0.30	0.35	0.50	0.75	1.00
c											
1.00											0.49
1.50	0.73	0.73	0.71	0.72	0.71	0.70	0.68	0.68	0.65	0.58	
2.00	0.71	0.72	0.72	0.77	0.76	0.75	0.74	0.74	0.68	0.60	
2.50	0.76	0.78	0.77	0.77	0.76	0.76	0.75	0.75	0.72		
3.00	0.72	0.74	0.75	0.75	0.75	0.75	0.75	0.75	0.72		
3.50	0.69	0.72	0.73	0.73	0.74	0.74	0.74	0.74	0.71		
4.00											
4.50	0.63	0.67	0.69	0.70	0.71	0.72	0.72	0.72	0.71	0.64	
5.00											
5.50											
6.00											
6.50	0.56	0.62	0.64	0.66	0.67	0.69	0.70	0.70	0.70	0.64	
7.00											

Table 6 Model efficiency for different combinations of the separation (x) and recession (C) coefficients

The combination of both parameters producing the highest model efficiencies differs from basin to basin. Although a fixed separation coefficient for all basins gives reasonable model results, calibration of the separation coefficient from basin to basin may lead to a (slightly) better model efficiency.

ciencies. However, the relation between the value of this coefficient and the topographical properties of the basins is not clear. Therefore, also possible changes of its value due to changed environmental conditions in future cannot be estimated. For these reasons we think that basin to basin calibration of this parameter will not necessarily lead to more reliable model results.

7 SENSITIVITY ANALYSIS OF THE DISCHARGE AT THE DOWNSTREAM (DUTCH) PART OF THE RIVER RHINE

As a first investigation of the effects of climate change on the River Rhine, the discharge for a series of temperature and precipitation changes has been calculated. The results will give an indication of the relative importance of these changes. The changes used are only hypothetical and have not been investigated on their probability of occurrence. However, the changes in precipitation between -20 and +20% combined with a temperature rise between 0 and +4 degrees Celsius are within the range of the expected climate changes in the coming decades. Although they cannot be used as forecast they can indicate the sensitivity of the Rhine basin.

7.1 Calculation of discharge scenarios

Monthly discharges were calculated for a temperature rise of 0, 2 and 4 degrees Celsius combined with a precipitation change of -10, -20, 0, +10 and +20 percent. The change in temperature is twice the long-term annual variability of the present-day climate, the change in precipitation is four times as large as the present-day annual variation. Scenarios with a temperature decrease were not evaluated because they are not likely to occur. The scenario analysis was carried out as follows:

Temperature increase was added to the record of monthly temperature of the 27 temperature stations for the period 1956-1980. A data set of monthly areal precipitation for the same period was used. Monthly precipitation was changed according to the percentages used. Based on these modified climate variables the monthly discharges of the River Rhine at the Dutch-German border (the Rees gauging station) were calculated with the RHINEFLOW model. The calculated discharges are compared with the results of a control run using the records of monthly temperature and areal precipitation for the period 1956-1980. The average monthly flows for the four seasons were calculated. Comparing model scenario discharge with observed present day discharge may give a false impression of the magnitude of change, since also the difference between the observed discharge and the calculated discharge of the control run is included in the estimated change. In order to reduce the model error only the discharge changes estimated by the model have been taken into account. Consequently the magnitude of change was calculated with:

$$change = \frac{Q_o + (Q_s - Q_c)}{Q_o}$$

in which

Q_o = the observed discharge (m^3/s)

Q_s = the scenario discharge as calculated by the model (m^3/s)

Q_c = the present day discharge as calculated by the model (m^3/s) (control run).

The method corrects for the model error for the seasonal discharge (fig. 19). This error is illustrated in this figure by the dots on the vertical axis, which represent the difference between the control run and the observed run.

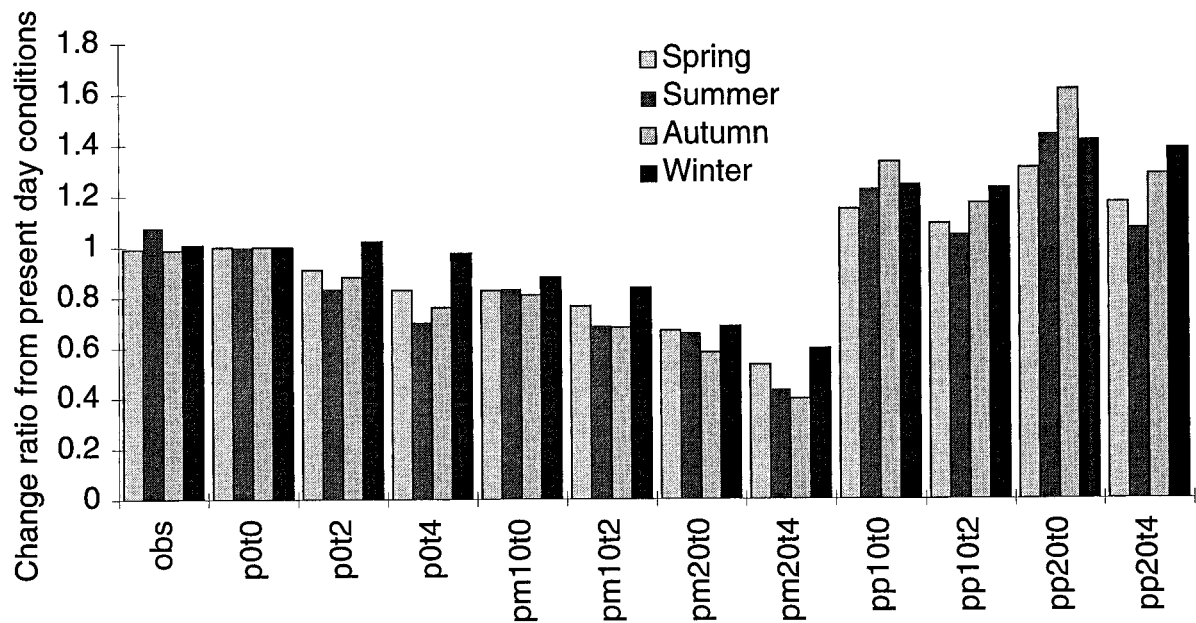

Figure 19 Change in seasonal discharge in the downstream part of the River Rhine for temperature and precipitation change scenarios

Legend: *obs* observed
p0t0 control run (model calculation for present-day conditions)
p0t2 precipitation change +0%, annual temperature +2C
p0t4 precipitation change +0%, annual temperature +4C
pm10t0 precipitation change -10%, annual temperature +0C
pm10t2 precipitation change -10%, annual temperature +2C
pm20t0 precipitation change -20%, annual temperature +0C
pm20t4 precipitation change -20%, annual temperature +4C
pp10t0 precipitation change +10%, annual temperature +0C
pp10t2 precipitation change +10%, annual temperature +2C
pp20t0 precipitation change +20%, annual temperature +0C
pp20t4 precipitation change +20%, annual temperature +4C

7.2 Results

The results of discharge changes due to changes in temperature and precipitation are shown in figure 18. The major conclusion of the analysis is that both the annual and the seasonal discharge of the River Rhine are more sensitive to a change in precipitation than to a change in temperature. This counts for all seasons. The following conclusions concerning the discharge changes at the German-Dutch border in the different seasons can be made:

- A temperature increase has little effect on the discharge. Discharge in all seasons, even in winter, reduces. Summer and autumn discharges are the most sensitive, whereas winter discharge hardly changes. The calculated change for this season is within the model error (about 3%). This result contradicts the results of Kwadijk (1991), who stated that the discharge of the River Rhine would be strongly affected by temperature change in the Alps. However, that study analysed a winter temperature rise of 4 degrees in the Alps only. For higher temperatures in all seasons it seems that the increase of snow-melt during winter in the Alps is compensated by a smaller discharge from the lower part of the basin.
- A precipitation increase has a large increasing effect on the discharge in all seasons. The discharge in autumn is the most sensitive, while the discharge in spring is the least. Summer discharge increases slightly more than winter discharge.
- A precipitation decrease has a large decreasing effect on the discharge in all seasons. Again the autumn discharge is the most sensitive. There is no difference in discharge reduction between the other seasons.
- A combination of temperature increase and precipitation decrease gives an amplified reduction of the discharge in all seasons. The effect is largest for autumn and smallest for winter.

- A combination of temperature increase and precipitation increase has a relatively large increasing effect on the discharge in all seasons. Winter discharge is the most sensitive in this scenario, while summer discharge is the least affected.

The effect of temperature change on the discharge is rather small. However, discharge in summer and autumn becomes more sensitive under wetter conditions. Under dryer conditions the effect of temperature change on the summer discharge decreases. Again for spring and winter discharge the effect remains the same. The temperature effect on the discharge in autumn also decreases in dryer conditions.

8 CONCLUSIONS AND DISCUSSION

8.1 Model performance and application

Due to the GIS basis the spatial differences of the model results, calculations on the monthly changes in the water balance compartments, can easily be evaluated. The model is able to produce reliable results at the scale of a catchment of the major tributaries of the River Rhine. Although the tributaries have different climatic, topographical and land use properties the model performs well under the prevailing climate conditions in different physiographic settings. The model performs well within a (present day) variation of precipitation of 10-20%. The model also calculates the average water loss due to evapotranspiration) and the major temporal storage (snow) accurately. Validation of calculated groundwater and soil water storage fluctuations was not possible since the data were not available within the time schedule of the project. To summarize, the model gives an accurate quantitative description of the water balance compartments under the present-day conditions.

Since the model calculates the changes in the water balance compartments accurately, it can be used to estimate the sensitivity of the discharge for changes in these compartments. These sensitivity studies give quantitative information about the direction of change. They also provide an indication of the rate of possible changes.

From the scenario studies made by the RHINEFLOW model and the earlier sensitivity study (Kwadijk, 1991), it can be concluded that the rainfall distribution and amount, controlling water input in the system, are the most important for the monthly discharge variations of the River Rhine in the downstream (Dutch) part of the river. These processes thus need more detailed description. Particularly changes in the Alpine area may have large effects. This area forms the major water supply for the Rhine basin and the hydrological properties of this area are both sensitive for a temperature and for a precipitation change.

Also important is temperature as this variable controls snow-melt and temporal water redistribution, and evapotranspiration. Land use type, which controls evapotranspiration seems less important for monthly discharge variations.

8.2 Model restrictions

In the first place there are several restrictions due to the spatial and temporal resolution of the model:

- The approach is not suited to make statements about the exact behaviour of each individual cell or small catchments. The main reasons for this restriction are:
 - (a) *The spatial scale of the areal precipitation used.*

The spatial distribution of the precipitation within the sub-areas is not taken into account. Evaluating cells having only small upstream areas will not yield reliable results since variability of this model variable is not sufficiently represented.
 - (b) *Representation of the drainage patterns.*

Drainage delimitation using a DEM, derived from a 1,500,000 scaled contour map, will lead to unreliable local drainage directions. Although drainage patterns and basin size for the main tributaries are satisfactory represented, small catchments are insufficiently represented to permit runoff calculations.
 - (c) *The number of temperature stations used.*

The use of a few temperature stations combined with a simple altitude/ temperature relation may lead to errors in cell temperature.
- The model is not able to reproduce the development of the snow cover in the lower parts of the Alps since accumulation and decay of this cover may occur several times a month. This may lead to errors in the calculated discharge in the Alpine part of the basin. Also the large local variations of precipitation in the Alps may lead to errors in the calculated snow storage. However, the effect of this model error on the discharge calculations will be small, since the area that introduces this error is relatively small.

Secondly, there are restrictions due to the model structure and the methods of process modelling:

- The model has inaccuracies under the present-day conditions. During long dry periods, the model calculates a soil water deficiency. The precipitation surplus marking the end of a dry period is firstly added to the water deficiency in the soil. Until soil water storage has reached field capacity the discharge is only generated from the slow runoff term. This may result into an underestimation of the discharge during the month(s) immediately after the dry period.
- The model uses empirical equations which have been developed and tested for the present-day climate. It is clear that, if these equations are not valid under other climatic conditions, the results of the sensitivity studies will be less reliable. The following changes can strongly influence models reliability:
 - (a) *Direct anti-transpirant effects due to increased CO₂ concentration.*
Changes of the water management of plants due to direct effects of the CO₂ will affect the actual evapotranspiration. On an annual basis the possible effects are described by Wigley and Jones (1984). They found that direct effects were probably of less importance than precipitation changes.
 - (b) *Changes in the average vertical temperature distribution in the Alps and the spatial precipitation distribution in the basin.*
These variables determine the temporal storage in snow and eventually temporal soil water shortage in the area.
 - (c) *Changes in cloudiness.*
Radiation is the driving force of potential evapotranspiration. The Thornthwaite equation assumes a relation between radiation and temperature and models evapotranspiration as a function of temperature. This equation is developed for the present climate conditions. Changes in cloudiness and air moisture may alter this relation between radiation and temperature.

8.3 Recommendations

It is clear that the results of the sensitivity studies only hold for the entire Rhine basin and probably not for smaller catchments. Local and even regional effects may well be influenced by processes that are of minor importance for the entire Rhine basin. Obviously, in the Alpine area snow storage and lake management are more important controlling factors than in the basin of the river Main. From these sensitivity studies recommendations can be made for the development of a more detailed model for the Rhine discharge:

- Research effort must be put into the estimation of the present and future spatial distribution of the precipitation.
- The snow-melt in the Alpine area and evapotranspiration for the whole basin must be modelled as close as possible to their physical basis, given the limitations in the availability of (scenario) input data. These processes will be influenced by a climate change.
- Other processes such as the water movement in the soil and in the lower aquifers can be modelled empirically using large time steps because:
 - (a) Until detailed spatial information on the geohydrological properties of shallow and deeper layers is available, there is no possibility to obtain the data necessary for modelling this water flow physically. Maybe remote sensing techniques will provide this data. However, on the scale of the River Rhine drainage basin the feasibility of such calculations must be doubted.
 - (b) It is unlikely that the properties of these compartments will alter under a climate change. Therefore the empirical equations developed to model this flow are not likely to alter.
- Possibilities to extend verification of hydrological models using data set of periods having different climate conditions should be studied.

Since the RHINEFLOW model has only been tested for the present day conditions the model results for future conditions may be less reliable. Verification of the model using a climate data set of a period having different climate conditions would be therefore useful. The last decade several scientists have studied historic documents and proxy data to reconstruct the climate for the period before the instrumental record (e.g. Lamb, 1984). Only recently projects have started to construct large data bases containing historical meteorological information and natural proxy data for large areas. (Pfister, 1992, Bradley pers. comm.). If the historical data base should provide a reliable set of the variables monthly precipitation, temperature and runoff at a spatial scale comparable to a tributary of the River Rhine, it could be used as a validation set for the RHINEFLOW model (Kwadijk et al, in press).

REFERENCES

- ABBOT, M.B., J.C. BATHURST, J.A. CUNGE, P.E. O'CONNELL, & J. RASMUSSEN (1986), An introduction to the European Hydrological System-Systeme Hydrologique Europeen, 'SHE', 1: History and Philosophy of a Physical Based, distributed modelling system. *Journal of Hydrology*, 45-59.
- BAUMGARTNER, A., E. REICHEL, UND G.WEBER (1983), *Der Wasserhaushalt der Alpen*. München: R. Oldenbourg.
- BEVEN, K. J., M.J. KIRBY, N. SCHOFIELD, & A.F. TAGG (1984), Testing a physically based flood forecasting model (TOPMODEL) for three UK Catchments. *Journal of Hydrology* 69. pp. 119-143.
- BEVEN, K.J. (1989), Changing ideas in hydrology: the case of physical-based models. *Journal of Hydrology* 105. pp. 157-172.
- BRAUN, L.N. (1985), Simulation of snow-melt – runoff in lowland and lower Alpine regions of Switzerland, Ph.D. thesis, Zürich: Geographisches Institut E.T.H.
- BRECHTEL H.M. AND G. SCHEELE (1982) *Erwirtschaftung von Grundwasser durch Land und Forstwirtschaftliche Massnahmen*, Hessische Forstliche Versuchsanstalt.
- BULTOT, F., A. COPPENS, G.L. DUPRIEZ, D. GELLENS & F. MEULENBERGHS (1988) Repercussions of a CO₂ doubling on the water cycle and on the water balance – a case study for Belgium. *Journal of Hydrology* 99, pp. 319-347.
- CHR/KHR (1976), *Le Bassin du Rhin / Das Rheingebiet*. Monographie Hydrologique / Hydrologischer Monographie. Part A: texts, part B: tables, part C: Maps and Diagrams, 's Gravenhage: Commission internationale de l'Hydrologie du bassin du Rhin/Internationale Kommission für die Hydrologie des Rheingebietes.
- CHR/KHR (1983), *La secheresse et les basses eaux de 1976/ die Trocken- und Niedrigwasser Periode 1976*. Rapport no.I-2 De La Commission internationale de l'Hydrologie du bassin du Rhin/Bericht no.I-2 der Internationale Kommission für die Hydrologie des Rheingebietes. 's Gravenhage: Commission internationale de l'Hydrologie du bassin du Rhin/Internationale Kommission für die Hydrologie des Rheingebietes.
- CHR/KHR (1991), *Proceedings KHR Workshop January 1991,; Einfluss von Klimaänderungen auf den Abfluss des Rheines*. 's Gravenhage: Commission internationale de l'Hydrologie du bassin du Rhin/Internationale Kommission für die Hydrologie des Rheingebietes.
- FLASCHKA, J.M. (1984), *Climatic change and water supply in the Great Basin region*. Master's thesis, Department of Hydrology and Water Resources University of Arizona.
- FLASCHKA, J.M., STOCKTON, C.W. & W.R. BOGGES (1987), *Climatic variation and surface water resources in the Great Basin region*. In: *Water Resources Bulletin* 23 (1) American Water Resources Association, February 1987, pp. 47-57.
- FRANCHINI M. & M. PACCIANI (1991), *Comparative analysis of several conceptual rainfall-runoff models*. *Journal of Hydrology* 122, pp. 161-219.
- GLEICK, P.H. (1987a), *The development and testing of a water balance model for climate impact assessment: Modelling the Sacramento Basin*. *Water Resources Research* 23, pp. 1049-1061.
- GLEICK, P.H. (1987b), *Regional hydrologic consequences of increases in atmospheric CO₂ and other trace gases*. *Climatic Change* 10, pp. 137-161.
- GROENENDIJK, H. (1989A), *Estimation of waterholding-capacity of soils in Europe. The compilation of a soil dataset*. Simulation report CABO-TT 19, Wageningen: Centre of Agrobiological Research, Department of Theoretical Production Ecology, Agricultural University, Wageningen, The Netherlands.
- GROENENDIJK, H. (1989b), *Estimation of waterholding-capacity of soils in Europe*. In: *Proceedings of the the Conference on Climate and Water, Helsinki, Finland 11-15 September, 1989*. vol. 1. Publications of the Academy of Finland, Helsinki. 293-300.
- IDSO, S.B. & A.J. BRAZEL (1984) *Rising atmospheric carbon dioxide concentrations may increase stream flow*. *Nature* 312, pp. 51-53.
- JENSON, S. & J. DOMINGUE,(1988) *Extracting topographic structure from digital elevation data for geographic information system analysis*. *Photogrammic Engineering and Remote Sensing*, 1988, pp. 1593-1600.
- KELLER R. (1958) *Das Wasserangebot in der Bundesrepublik Deutschland*. *Forschungen zur Deutsche Landeskunde* 57, pp.103-105.
- KIRKBY, M.J., P.S. NADEN, T.P. BURT, & D.P. BUTCHER (1987), *Computer simulation in Physical Geography*. Chichester: John Wiley & Sons.
- KLEMES, V. (1986), *Operational testing of hydrological simulation models*. *Hydrological Sciences*

- Journal -Des Sciences Hydrologiques 31, pp.13-24.
- KWADIJK, J.C.J (1991), Sensitivity of the River Rhine discharge to environmental change, a first tentative assessment. *Earth Surface Processes and Landforms* 16, pp. 627-637.
- KWADIJK, J.C.J. & H. MIDDELKOOP (in press), Estimation of impact of climate change on the peak discharge probability of the River Rhine (Climatic Change),
- LAMB, H.H.(1984), Climate and History in Northern Europe and elsewhere. In: Mörner N.A. & Karlén W.(eds), *Climatic changes on a yearly to millennial basis*. D.Reidel Publish. Company, pp. 225-240.
- MARKS, D., J. DOZIER, & J. FREW (1984) Automated basin delineation from digital elevation data. *Geo- Processing* 2, pp. 299-311.
- MARTINEC, J., M. ROHRER, & H. LANG (1992), *Schneehöhe und Schneedecke*, Hydrologische Atlas der Schweiz.
- MIMIKOU, M., Y. KOUVOPOULOS, G. CAVADIAS & N. VAYIANOS (1991), Regional effects of climate change. *Journal of Hydrology* 23, pp. 119-146.
- MORRIS, D. & R. HEERDEGEN (1988), Automatically derived catchment boundaries and channel networks and their hydrological applications. *Geomorphology* 1, pp. 131-141.
- MOUSSAVI, M., G. WYSEURE, & J. FEYEN (1989), Estimation of melt rate in seasonally snow covered mountainous areas. *Hydrological Sciences-Journal-des Sciences Hydrologiques* 34, pp. 249-263.
- NASH, J.E. & J.V. SUTCLIFF (1970), River flow forecasting through conceptual models. Part 1-a discussion of principles. *Journal of Hydrology* 10, pp. 282-290.
- NEMEC J. & J. SCHAACKE (1982), Sensitivity of water resource systems to climate variations. *Hydrological Sciences-Journal-des Sciences Hydrologiques* 27-3, pp. 327-343.
- PALUTIKOV, J.P.(1987), Some possible impacts of greenhouse gas induced climatic change on water resources in England and Wales. In: *The influence of Climate change and climate variability on the Hydrologic regime and water resources* (proceedings of the Vancouver Symposium. IAHS Publ. 168, pp. 585-596.
- PENMANN, H.L. (1956), Evaporation: An introductory survey. *Netherlands Journal of Agricultural Science* 4, pp. 9-29.
- PEREIRA, A.R. & A.P. CAMARGO (1989), An analysis of the criticisms of Thornthwaite's equation for estimating potential evapotranspiration. *Agricultural and Forest Meteorology* 46, pp. 149-157.
- PFISTER, C.(1992), Monthly temperature and precipitation in central Europe 1525-1979: Quantifying documentary evidence on weather and its effects. In: *Climate Since A.D. 1500*, R.S. Bradley & P.D. Jones (eds), Routledge London, pp. 118-142.
- REVELLE, R. R. & P.E. WAGGONER (1983), Effects of a carbon dioxide-induced climate change on water supplies in the Western United States. In: *Changing Climate. Report of the Carbon Dioxide Assessment Committee*. Washington, D C National Academy Press.
- RIJKSWATERSTAAT (1988), Impact of sealevel rise on society. Rapport fase 1 van onderzoek. Delft Hydraulics 's Gravenhage: Rijkswaterstaat (in Dutch).
- SCHÄDLER, B. (1985), *Der Wasserhaushalt der Schweiz*. Mitteilungen der Landeshydrologie no.6. Bern/ Berne, Schweiz: Bundesamt für Umweltschutz. Abteilung: Landeshydrologie.
- SHIKLOMANOV, I.A. (1989), Anthropogenic changes of climate, water resources and water management problems. In: *Proceedings on the conference on climate and water*, Helsinki, Finland 11-15 September, 1989. vol. 1. Publications of the Academy of Finland, Helsinki, pp. 310-348.
- STOCKTON, C.W. & W.R. BOGGES (1979), Geohydrological implications of climate change on water resource development. US Army Coastal Engineering Research Centre.
- SANDERSON, M. & L. WONG (1987), Climatic change and Great Lakes water levels. In: *The influence of climate change and climatic variability on the hydrologic regime and water resources*. IAHS publication No. 168, pp. 477-487.
- SINGH, B. (1987). The impacts of CO₂-induced climate change on hydro-electric generation potential in the James Bay Territory of Quebec. *The influence of climate change and climatic variability on the hydrologic regime and water resources*. IAHS publication No. 168, pp. 403-418.
- THOMPSON, S.A. (1992), Simulation of climate change impacts on water balances in the Central United States. *Physical Geography* 13, pp. 31-52.
- THORNTHWAITE, C.W. & J.R. MATHER (1957), Instructions and tables for computing potential evapotranspiration and the water balance, *Publications in Climatology* X, pp. 183-243.
- TOMLIN, C.D. (1983), Digital cartographic modelling techniques in environmental planning. Unpublished Ph.D. thesis, Yale University, Connecticut.
- U.S. ENVIRONMENTAL PROTECTION AGENCY (1984), Potential Climatic impacts of increa-

- sing atmospheric CO₂ with emphasis on water availability and hydrology in the United States. EPA Office of Policy, Planning and Evaluation, Washington DC.
- VAN DEURSEN, W.P.A. & J.C.J. KWADIJK (1990), Using the Watershed tools for modelling the Rhine catchment. In: Proceedings on the first European Conference on G.I.S, pp. 254-263.
- VAN DEURSEN, W.P.A. & J.C.J. KWADIJK (1993), RHINEFLOW: an integrated GIS water balance model for the River Rhine. In: K.Kovar & H.P.Nachtnebel, Application of Geographic Information Systems in hydrology and water resources management. Proceedings of the Conference on HYDROGIS. IHAS publication 211, pp. 507-519.
- WARD, R.C. & M. ROBINSON (1990), Principles of Hydrology. London: Mc Graw-Hill.
- WASHINGTON, W.M. & A.G. MEEHL (1984), Seasonal cycle experiment on the climate sensitivity due to a doubling of CO₂ with an atmospheric general circulation model coupled to a simple mixed-layer ocean model. Journal of Geophysical Research 89, 6, pp. 9475-9503.
- WIGLEY, T.M.L. & P.D. JONES (1984), Influences of precipitation changes and direct CO₂ effects on stream flow. Nature 314, pp. 149-152.
- WILSON, C.A. & J.F.B. MITCHELL (1987), Simulated climate and CO₂-induced climate change over Western Europe. Climate Change 10, pp. 11-42.
- WORLD METEOROLOGICAL ORGANIZATION (W.M.O.) (1987), Water resources and climatic change: sensitivity of water resource systems to climatic change and variability. WMO/Technical document 247, World Meteorological Organization.

APPENDIX THE CALCULATION OF THE TOTAL WATER BALANCE

In a water balance model the water budget can be reduced to a mass balance equation:

$$\text{Inflow} - \text{Outflow} = \text{Storage Change}$$

The RHINEFLOW model describes the water balance at location (x,y) in month (t) by:

$$R_{x,y,t} = P_{x,y,t} - AE_{x,y,t} + dS_{x,y,t}$$

$$S_{x,y,t} = SS_{x,y,t} + GWS_{x,y,t} + SNS_{x,y,t}$$

in which

R is the runoff (mm);

P is precipitation (mm);

S is the water volume stored in the soil, snow, glaciers and groundwater (mm);

AE is water loss due to actual evapotranspiration (mm);

dS is change in water volume stored (mm);

SS is water stored in the soil and as shallow groundwater (mm);

GWS is the water stored in aquifers and as deeper groundwater (mm);

SNS the amount of water stored in the snow cover (mm).

Calculation of the water balance of the snow compartment

The water balance in snow is

$$SNS_{x,y,t} = SNS_{x,y,t-1} + SNOWFALL_{x,y,t} - MELT_{x,y,t}$$

Precipitation is divided over snowfall and rainfall which is calculated with:

$$\begin{aligned} &\text{IF } T_{x,y,t} < 0 \text{ THEN} \\ &\quad SNOWFALL_{x,y,t} = P_{x,y,t} \\ &\quad RAIN_{x,y,t} = 0 \\ &\text{ELSE} \\ &\quad RAIN_{x,y,t} = P_{x,y,t} \\ &\quad SNOWFALL_{x,y,t} = 0 \end{aligned}$$

in which

T is temperature (degree Celsius);

P is precipitation (mm).

Snow melt is calculated using

$$\begin{aligned} &\text{IF } T_{x,y,t} > 0 \text{ THEN} \\ &\quad MELT_{x,y,t} = \text{MAX}(c * T_{x,y,t}, SNS_{x,y,t-1}) \\ &\text{ELSE} \\ &\quad MELT_{x,y,t} = 0 \end{aligned}$$

in which

c is a snowmelt parameter (mm*degree/C).

Calculation of potential and crop evapotranspiration

Potential evapotranspiration ET_{ref} (mm) is calculated as a function of temperature and land use type using the equations of Thornthwaite:

IF $T_{x,y,t} > 0$ THEN
 $ET_{ref\ x,y,t} = D_{x,y,t} * 1.6 * (10 * T_{x,y,t}/H_{x,y})^a$
 ELSE
 $ET_{ref\ x,y,t} = 0$

in which

D is a parameter depending on the daylength (hours of sunshine) which is a function of geographical latitude;

T is the average temperature (degree Celsius) in the month t;

H,a are constants

$$H = \sum_{jan}^{dec} (T_m/5)^{1.5}$$

$$a = 0.49 + 0.01791 * H - 0.0000771 * H^2 + 0.000000675 * H^3$$

in which

T_m is the long term average monthly temperature of the months January to December.

The reference evapotranspiration is converted into potential evapotranspiration ET as a function of ET_{ref} and land use:

$$ET_{x,y,t} = ET_{ref\ x,y,t} * k_{c\ x,y,t}$$

in which

k_c is a crop coefficient (-)

Calculation of the soil compartment water balance and actual evapotranspiration

The water balance is calculated using the Thornthwaite-Mather equations:

$$SS_{x,y,t} = SS_{x,y,t-1} + Soilinput_{x,y,t} - Soiloutput_{x,y,t}$$

where

$$Soilinput_{x,y,t} = RAIN_{x,y,t} + MELT_{x,y,t}$$

$$Soiloutput_{x,y,t} = seepage_{x,y,t} + AE_{x,y,t}$$

The actual evapotranspiration AE is calculated as

IF $P_{x,y,t} + MELT_{x,y,t} \geq ET_{x,y,t}$ THEN
 $AE_{x,y,t} = ET_{x,y,t}$
 ELSE
 $AE_{x,y,t} = P_{x,y,t} + MELT_{x,y,t} + (SS_{x,y,t-1} - S_{max\ x,y} * \exp(-APWL_{x,y,t}/S_{max\ x,y}))$

where

APWL is the accumulated potential water loss

S_{max} is maximum water holding capacity of soil

The Accumulated Potential Water Loss (APWL) is calculated as

IF $P_{x,y,t} > ET_{x,y,t}$ THEN
 $APWL_{x,y,t} = 0$
 ELSE
 $APWL_{x,y,t} = S_{max} * \ln(S_{max\ x,y}/SS_{x,y,t-1}) - (P_{x,y,t} - ET_{x,y,t})$

Direct runoff and seepage are determined using:

```

IF  $P_{x,y,t} > ET_{x,y,t}$  AND  $SS_{x,y,t-1} + P_{x,y,t} + MELT_{x,y,t} - ET_{x,y,t} > S_{max,x,y}$  THEN
    direct runoff $_{x,y,t} = X * (SS_{x,y,t-1} + P_{x,y,t} + MELT_{x,y,t} - ET_{x,y,t} - S_{max,x,y})$ 
ELSE
    direct runoff $_{x,y,t} = 0$ 

IF  $P_{x,y,t} > ET_{x,y,t}$  AND  $SS_{x,y,t-1} + P_{x,y,t} + MELT_{x,y,t} - ET_{x,y,t} > S_{max,x,y}$ 
    seepage $_{x,y,t} = (1-X) * (SS_{x,y,t-1} + P_{x,y,t} + MELT_{x,y,t} - ET_{x,y,t} - S_{max,x,y})$ 
ELSE
    seepage $_{x,y,t} = 0$ 

```

in which

X determines the separation between direct and delayed runoff.

Calculation of the water balance of the groundwater compartment

The water balance of the groundwater compartment is calculated with:

$$GWS_{x,y,t} = GWS_{x,y,t-1} + seepage_{x,y,t} - delayed\ runoff_{x,y,t}$$

$$delayed\ runoff_{x,y,t} = groundwater_{x,y,t-1} / C$$

where

C is a calibration parameter (months) depending on the topography and geohydrological properties of the basin.

Calculation of the discharge

The total runoff produced by each grid cell is:

$$\text{Total runoff} = \text{Delayed runoff} + \text{Direct runoff}$$

The runoff produced by a sub-catchment or the total basin can be determined using

$$\text{Basin runoff} = \sum_{\text{all cells upstream}} \text{Total runoff}$$

CHR/KHR (1978): Das Rheingebiet, Hydrologische Monographie. Staatsuitgeverij, Den Haag/
Le bassin du Rhin. Monographie Hydrologique. Staatsuitgeverij, La Haye. ISBN 90-12017-75-0

Berichte der KHRRapports de la CHR

- I-1 GREBNER, D. (1982): Objektive quantitative Niederschlagsvorhersagen im Rheingebiet. Stand 1982 (nicht mehr lieferbar) / Prévisions objectives et quantitatives des précipitations dans le bassin du Rhin. Etat de la question en 1982 (Edition Epuisée)
- I-2 GERHARD, H.; MADE, J.W. VAN DER; REIFF, J.; VREES, L.P.M. DE (1983): Die Trocken- und Niedrigwasserperiode 1976. (2. Auflage 1985) / La sécheresse et les basses eaux de 1976 (2ème édition, 1985). ISBN 90-70980-01-0
- I-3 HOFIUS, K. (1985): Hydrologische Untersuchungsgebiete im Rheingebiet / Bassins de recherches hydrologiques dans le bassin du Rhin. ISBN 90-70980-02-9
- I-4 BUCK, W.; KIPGEN, R.; MADE, J.W. VAN DER; MONTMOLLIN, F. DE; ZETTL, H.; ZUMSTEIN, J.F. (1986): Berechnung von Hoch- und Niedrigwasserwahrscheinlichkeit im Rheingebiet / Estimation des probabilités de crues et d'étiages dans le bassin du Rhin. ISBN 90-70980-03-7
- I-5 TEUBER, W.; VERAART, A.J. (1986): Abflußermittlung am Rhein im deutsch-niederländischen Grenzbereich / La détermination des débits du Rhin dans la région frontalière germano-hollandaise. ISBN 90-70980-04-5
- I-6 TEUBER, W. (1987): Einfluß der Kalibrierung hydrometrischer Meßflügel auf die Unsicherheit der Abflußermittlung. Ergebnisse eines Ringversuchs / Influence de l'étalonnage des moulinets hydrométriques sur l'incertitude des déterminations de débits. Résultats d'une étude comparative. ISBN 90-70980-05-3
- I-7 MENDEL, H.-G. (1988): Beschreibung hydrologischer Vorhersagemodelle im Rheineinzugsgebiet / Description de modèles de provision hydrologiques dans le bassin du Rhin. ISBN 90-70980-06-1
- I-8 ENGEL, H.; SCHREIBER, H.; SPREAFICO, M.; TEUBER, W.; ZUMSTEIN, J.F. (1990): Abflußermittlung im Rheingebiet im Bereich der Landesgrenzen / Détermination des débits dans les régions frontalières du bassin du Rhin. ISBN 90-70980-01-x
- I-9 CHR/KHR (1990): Das Hochwasser 1988 im Rheingebiet / La crue de 1988 dans le bassin du Rhin. ISBN 90-70980-11-8
- I-10 NIPPES, K.-R. (1991): Bibliographie des Rheingebietes / Bibliographie du bassin du Rhin. ISBN 90-70980-13-4
- I-11 BUCK, W.; FELKEL, K.; GERHARD, H.; KALWEIT, H.; MALDE, J. VAN; NIPPES, K.-R.; PLOEGER, B.; SCHMITZ, W. (1993): Der Rhein unter der Einwirkung des Menschen – Ausbau, Schifffahrt, Wasserwirtschaft / Le Rhin sous l'influence de l'homme – Aménagement, navigation, gestion des eaux. ISBN 90-70980-17-7
- I-12 SPREAFICO, M.; MAZIJK, A. VAN (Red.) (1993): Alarmmodell Rhein. Ein Modell für die operationelle Vorhersage des Transportes von Schadstoffen im Rhein. ISBN 90-70980-18-5
- I-13 SPREAFICO, M.; MAZIJK, A. VAN (réd.) (1997): Modèle d'alerte pour le Rhin. Un modèle pour la prévision opérationnelle de la propagation de produits nocifs dans le Rhin. ISBN 90-70980-23-1
- I-14 EMMENEGGER, CH. ET AL. (1997): 25 Jahre KHR. Kolloquium aus Anlaß des 25jährigen Bestehens der KHR / 25 ans de la CHR. Colloque à l'occasion du 25^e anniversaire de la CHR. ISBN 90-70980-24-x
- I-15 ENGEL, H. (1997): Fortschreibung der Monographie des Rheingebietes für die Zeit 1971-1990 / Actualisation de la Monographie du Bassin du Rhin pour la période 1971-1990. ISBN 90-70980-25-8
- I-16 GRABS, W. (ed.) (1997): Impact of climate change on hydrological regimes and water resources management in Europe. ISBN 90-70980-26-6
- I-17 ENGEL, H. (1999): Eine Hochwasserperiode im Rheingebiet. Extremereignisse zwischen Dez. 1993 und Febr. 1995. ISBN 90-70980-28-2
- Katalog/Catalogue 1 SPROKKEREEF, E. (1989): Verzeichnis der für internationale Organisationen wichtigen Meßstellen im Rheingebiet/
Tableau de stations de mesure importantes pour les organismes internationaux dans le bassin du Rhin. ISBN 90-70980-08-8

- II-1 MADE, J.W. VAN DER (1982): Quantitative Analyse der Abflüsse (nicht mehr lieferbar) / Analyse quantitative des débits (édition épuisée)
- II-2 GRIFFIOEN, P.S. (1989): Alarmmodell für den Rhein / Modèle d'alerte pour le Rhin. ISBN 90-70980-07-x
- II-3 SCHRÖDER, U. (1990): Die Hochwasser an Rhein und Mosel im April und Mai 1983 / Les crues sur les bassins du Rhin et de la Moselle en avril et mai 1983. ISBN 90-70980-09-6
- II-4 MAZIJK, A. VAN; VERWOERDT, P.; MIERLO, J. VAN; BREMICKER, M.; WIESNER, H. (1991): Rheinalarmmodell Version 2.0 – Kalibrierung und Verifikation / Modèle d'alerte pour le Rhin version 2.0 – Calibration et vérification. ISBN 90-70980-12-6
- II-5 MADE, J.W. VAN DER (1991): Kosten-Nutzen-Analyse für den Entwurf hydrometrischer Meßnetze / Analyse des coûts et des bénéfices pour le projet d'un réseau hydrométrique. ISBN 90-70980-14-2
- II-6 CHR/KHR (1992): Contributions to the European workshop Ecological Rehabilitation of Floodplains, Arnhem, The Netherlands, 22-24 September 1992. ISBN 90-70980-15-0
- II-7 NEMEC, J. (1993): Comparison and selection of existing hydrological models for the simulation of the dynamic water balance processes in basins of different sizes and on different scales. ISBN 90-70980-16-9
- II-8 MENDEL, H.-G. (1993): Verteilungsfunktionen in der Hydrologie. ISBN 90-70980-19-3
- II-9 WITTE, W. KRAHE, P.; LIEBSCHER, H.-J. (1995): Rekonstruktion der Witterungsverhältnisse im Mittelrheingebiet von 1000 n. Chr. Bis heute anhand historischer hydrologischer Ereignisse. ISBN 90-70980-20-7
- II-10 WILDENHAHN, E.; KLAHOLZ, U. (1996): Große Speicherseen im Einzugsgebiet des Rheins. ISBN 90-70980-21-5
- II-11 SPREAFICO, M.; LEHMANN, C.; SCHEMMER, H.; BURGENDORFFER, M. KOS, T.L. (1996): Feststoffbeobachtung im Rhein, Beschreibung der Messgeräte und Messmethoden. ISBN 90-70980-22-3
- II-12 SCHÄDLER, B. (Red.) (1997): Bestandsaufnahme der Meldesysteme und Vorschläge zur Verbesserung der Hochwasservorhersage im Rheingebiet. Schlussbericht der IKSAR-Arbeitsinheit 'Meldesysteme / Hochwasservorhersage' – Projektgruppe 'Aktionsplan Hochwasser' / Annonce et prévision des crues dans le bassin du Rhin. Etat actuel et propositions d'amélioration. Rapport final de l'unité de travail 'Systèmes d'annonce / prévision des crues' – Groupe de projet 'Plan d'action contre les inondations'. ISBN 90-70980-27-4
- II-13 DRÖGE, B.; HENNOCH, H.; KELBER, W.; MAHR, U.; SWANENBERG, T.; THIELEMANN, T.; THURM, U. (1999): Entwicklung eines Längsprofils des Rheins. Bericht für die Musterstrecke von Rheinkm 800 – 845. Arbeitsgruppe 'Sedimenttransport im Rhein' Projekt 3. ISBN 90-70980-29-0
- II-14 MAZIJK, A. VAN; LEIBUNDGUT, CH.; NEFF, H.-P. (1999): Rhein-Alarm-Modell Version 2.1. Erweiterung um die Kalibrierung von Aare und Mosel. Kalibrierungsergebnisse von Aare und Mosel aufgrund der Markierversuche 05/92, 11/92 und 03/94. ISBN 90-70980-30-4
- II-15 KWADIJK, J.; DEURSEN, W. VAN (1999): Development and testing of a GIS based water balance model for the Rhine drainage basin. ISBN 90-70980-31-2

Einige Informationen über die:

INTERNATIONALE KOMMISSION FÜR DIE HYDROLOGIE DES RHEINGEBIETES (KHR)

Gründung

1970 Im Rahmen der Internationalen Hydrologischen Dekade (IHD) der UNESCO.

1975 Fortsetzung der Arbeiten im Rahmen des Internationalen Hydrologischen Programms (IHP) der UNESCO und des Operationellen Hydrologie-Programms (OHP) der WMO.

1978 Unterstützung der Arbeiten der Kommission durch Austausch einer Verbal-Note zwischen den mitarbeitenden Ländern.

Aufgaben

- Förderung der Zusammenarbeit hydrologischer Institutionen und Dienste im Einzugsgebiet des Rheins.
- Durchführung von Untersuchungen über die Hydrologie des Rheingebietes und Austausch der Ergebnisse diesbezüglicher Studien.
- Förderung des Austausches von hydrologischen Daten und Informationen im Rheingebiet (z.B. aktuelle Daten, Vorhersagen).
- Entwicklung von standardisierten Verfahren für die Sammlung und Bearbeitung hydrologischer Daten in den Rheinanliegerstaaten.

Mitarbeitende Länder

Schweiz, Österreich, Bundesrepublik Deutschland, Frankreich, Luxemburg, Niederlande

Arbeitssprachen

Deutsch und Französisch

Organisation

Ständige Vertreter (Sitzungen 2mal pro Jahr) unterstützt von einem ständigen Sekretariat. Die Bearbeitung von Projekten wird von Rapporteurs und internationalen Arbeitsgruppen durchgeführt.

Quelques informations sur la:

COMMISSION INTERNATIONALE DE L'HYDROLOGIE DU BASSIN DU RHIN (CHR)

Institution

1970 Dans le cadre de la Décennie Hydrologique Internationale (DHI) de l'UNESCO.

1975 Poursuite des travaux dans le cadre du Programme Hydrologique International (PHI) de l'UNESCO et du Programme d'Hydrologie Opérationnelle (PHO) de l'OMM.

1978 Appui des travaux de la Commission par l'échange d'une note verbale entre les pays concernés.

Tâches

- Encourager la coopération entre les instituts et les services actifs dans le bassin du Rhin.
- Réalisation d'études hydrologiques dans le bassin du Rhin et échange de résultats des études concernées.
- Encourager l'échange de données et d'informations hydrologiques dans le bassin du Rhin (p.ex. données actuelles, prévisions).
- Elaboration de méthodes standardisées pour la collecte et le traitement des données hydrologiques dans les Etats riverains du Rhin.

Pays participants

la Suisse, l'Autriche, la République Fédérale d'Allemagne, la France, le Luxembourg, les Pays-Bas

Langues de travail

allemand et français

Organisation

Les représentants permanents (réunions deux fois par an) sont soutenus par le secrétariat permanent. Les études sont réalisées par des rapporteurs et des groupes de travail internationaux.

Auswahl der laufenden Arbeiten

‘Änderungen im Abflußregime’

- Beschreibung des Einflusses der menschlichen Aktivitäten auf die Rheinabflüsse.
- Bestimmung der Auswirkungen von Bodennutzungs- und Klimaänderungen auf das Abflußregime des Rheins.
- Untersuchungen über Auswirkungen des Waldes auf den Wasserhaushalt.

‘Fließzeiten’

- Ermitteln von Fließzeiten und Stofftransport im Rhein zur Verbesserung des Rheinalarmmodells (in Zusammenarbeit mit der IKS).

‘Sediment’

- Verbesserung und Standardisierung der Verfahren zur Messung von Schwebstoffgehalten und Bodentransport des Sediments.
- Beschreibung des Sedimenthaushaltes im Fluß.

‘Fortschreibung der Monographie’

- Übersicht hydrologischer Daten über die Perioden 1971-1980 und 1981-1990 als Fortsetzung der im Jahre 1978 veröffentlichten Monographie ‘Das Rheingebiet’.

Fertiggestellte Arbeiten

sie Publikationsliste, Seite 61

Principaux thèmes en cours

‘Changements dans le régime des débits’

- Description de l’impact des activités humaines sur le débit du Rhin.
- Détermination des effets des changements du climat et de l’utilisation du sol sur le régime des débits du Rhin.
- Etude de l’influence du forêt sur l’hydrologie.

‘Temps d’écoulement’

- Détermination des temps d’écoulement et de transport des substances dans le Rhin pour l’amélioration du modèle d’alerte du Rhin (en collaboration avec la CIPR).

‘Sédiments’

- Amélioration et standardisation des méthodes pour la mesure des matières en suspension et du charriage de fond.
- Description de la situation de la sédimentation dans le fleuve.

‘Actualisation de la Monographie’

- Données hydrologiques sur les périodes 1971-1980 et 1981-1990 complétant celles de la monographie hydrologique ‘le Bassin du Rhin’ publiée en 1978.

Travaux effectués

voir la liste de publications, page 61

Enige gegevens betreffende de:

INTERNATIONALE COMMISSIE VOOR DE HYDROLOGIE VAN HET RIJNGEBIED (CHR)

Oprichting

1970 In het kader van het Internationaal Hydrologisch Decennium (IHD) van de UNESCO.

1975 Voortzetting van de werkzaamheden in het kader van het Internationaal Hydrologisch Programma (IHP) van de UNESCO en het Operationeel Hydrologisch Programma (OHP) van de WMO.

1978 Ondersteuning van het werk van de Commissie door een nota-uitwisseling tussen de samenwerkende landen.

Taken

- Bevordering van samenwerking tussen hydrologische instituten en diensten in het stroomgebied van de Rijn.
- Uitvoeren van hydrologische studies in het Rijngebied en uitwisseling van de onderzoeksresultaten.
- Bevorderen van de uitwisseling van hydrologische gegevens en informatie in het Rijngebied (bijv. actuele gegevens, voorspellingen).
- Ontwikkeling van standaardmethoden voor het verzamelen en bewerken van hydrologische gegevens in de Rijnsoeverstaten.

Deelnemende landen

Zwitserland, Oostenrijk, Bondsrepubliek Duitsland, Frankrijk, Luxemburg, Nederland

Voertalen

Duits en Frans

Organisatie

Vaste vertegenwoordigers (vergaderingen tweemaal per jaar) ondersteund door een permanent secretariaat. Onderzoeken worden door rapporteurs en internationale werkgroepen uitgevoerd.

Some information on the:

INTERNATIONAL COMMISSION FOR THE HYDROLOGY OF THE RHINE BASIN (CHR)

Foundation

1970 Within the framework of UNESCO's International Hydrological Decade (IHD).

1975 Continuation of activities in the framework of UNESCO's International Hydrological Programme (IHP) and the Operational Hydrology Programme (OHP) of WMO.

1978 Support of the Commission's activities by exchange of a verbal note between the participating countries.

Tasks

- Support of co-operation between hydrological institutes and services active in the catchment area of the Rhine.
- Executing hydrological studies in the Rhine basin and exchange of research results.
- Promoting the exchange of hydrological data and information in the Rhine basin (e.g. current data, forecasts).
- Development of standardized methods for collecting and processing hydrological data in the Rhine riparian states.

Participating countries

Switzerland, Austria, Federal Republic of Germany, France, Luxemburg, the Netherlands

Working languages

German and French

Organization

Permanent representatives (meetings twice a year) supported by a permanent secretariat. Studies are carried out by rapporteurs and international working groups.

Belangrijkste lopende onderzoeken

‘Veranderingen in het afvoerregime’

- Beschrijving van de invloed van menselijke activiteiten op de Rijnafvoeren
- Bepaling van de invloed van veranderingen in bodemgebruik en klimaat op het afvoerregime van de Rijn.
- Onderzoek naar de invloed van bos op de waterhuishouding.

‘Stroomtijden’

- Bepaling van de stroomtijden en stoftransport in de Rijn ter verbetering van het alarmmodel voor de Rijn (in samenwerking met de IRC).

‘Sediment’

- Verbetering en standaardisering van meetmethoden voor gehalten aan zwevend materiaal en bodemtransport.
- Beschrijving van de sedimenthuishouding in de rivier.

‘Voortzetting Monografie’

- Overzicht van hydrologische gegevens over de perioden 1971-1980 en 1981-1990 als voortzetting van de in 1978 uitgegeven hydrologische monografie ‘Het stroomgebied van de Rijn’.

Afgesloten onderwerpen

zie lijst van publikaties, blz. 61

Selection of current subjects

‘Changes in the discharge regime’

- Description of the impact of human activities on the Rhine discharges.
- Determination of the effect of changes in land use and climate on the discharge regime of the Rhine.
- Research into the effects of forest on the hydrology of the basin.

‘Travel times’

- Determination of the travel times and constituent transport in the Rhine for the improvement of the alarm model for the Rhine (in co-operation with CIPR/IKSR).

‘Sediment’

- Improvement and standardization of methods to measure suspended load and bed-load transport.
- Description of sediment characteristics of the river.

‘Continuation of the Monograph’

- Hydrological data for the periods 1971-1980 and 1981-1990 as a continuation of the hydrological monograph ‘The Rhine basin’ published in 1978.

Completed projects

see list of publications, p. 61

KOLOPHON / COLOPHON

Drucker / imprimeur : Veenman drukkers, Ede

Papier : Chlorfrei M.C. / sans chlor M.C.

ISBN : 90-70980-31-2



Secretariaat CHR/KHR
Maerlant 16

Postbus 17
NL-8200 AA Lelystad
Niederlande/Pays-Bas

